

Sauna 40 (430x460)

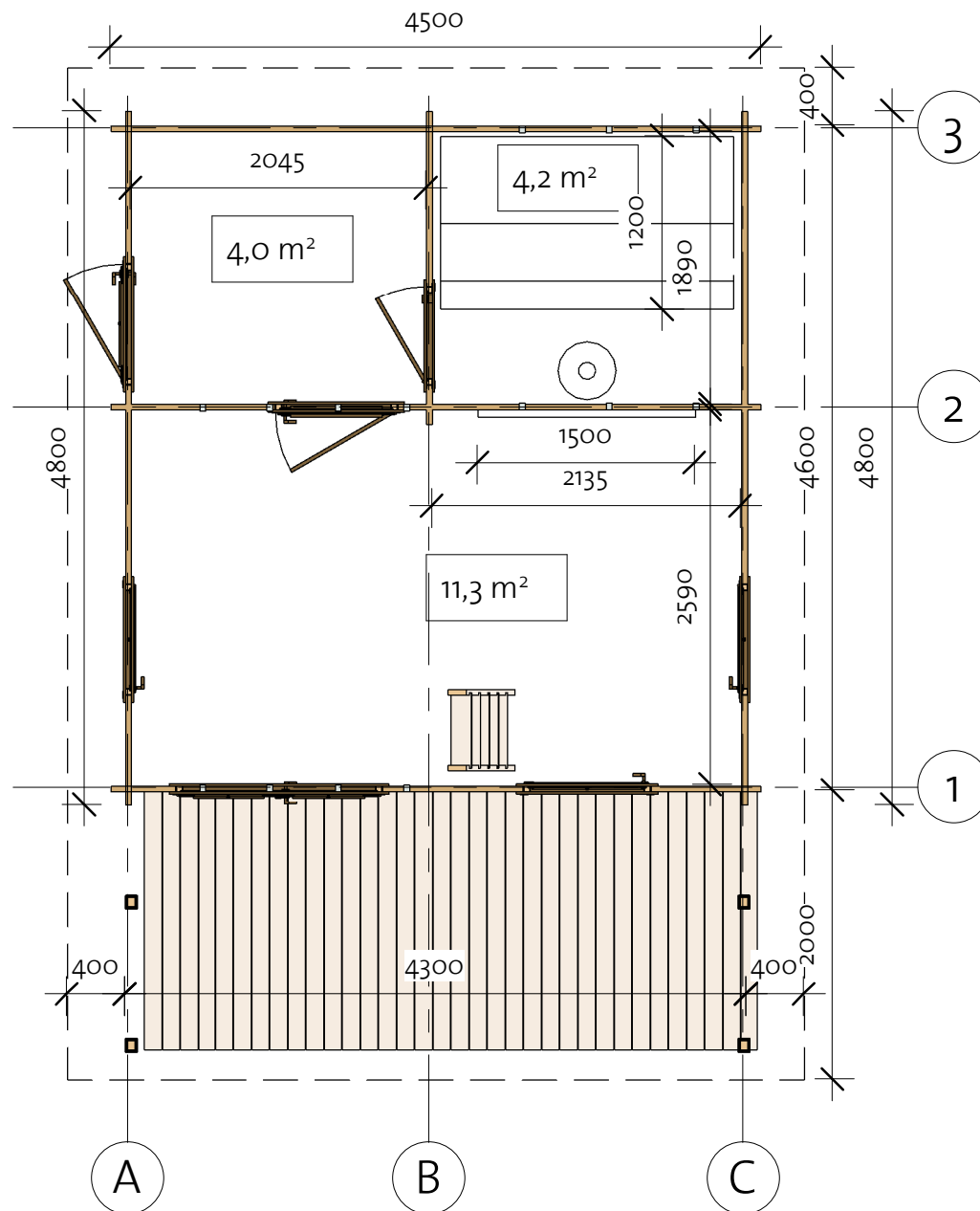

92203311_260228



Sauna 40 (430x460)

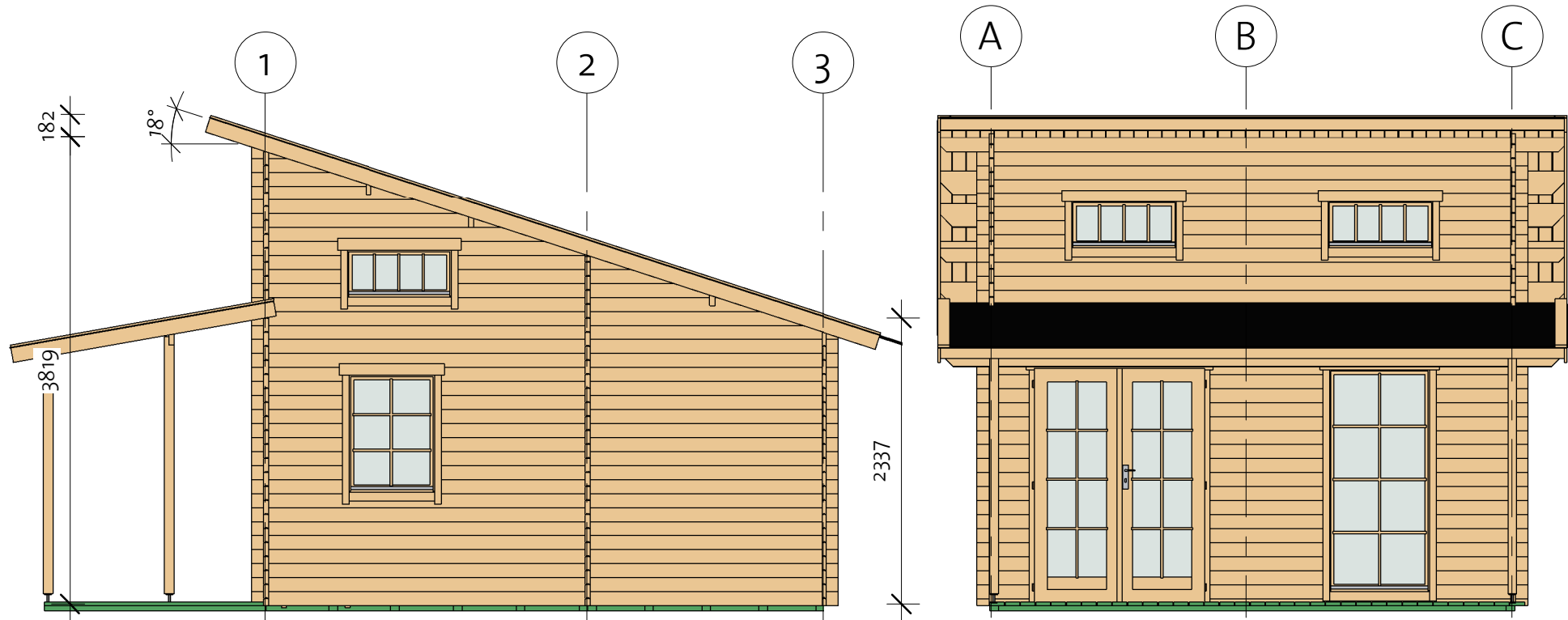

92203311_260228

 **VIKTRÄ**

Sauna 40 (430x460)





92203311_260228

 **VIKTRÄ**

Sauna 40 (430x460)

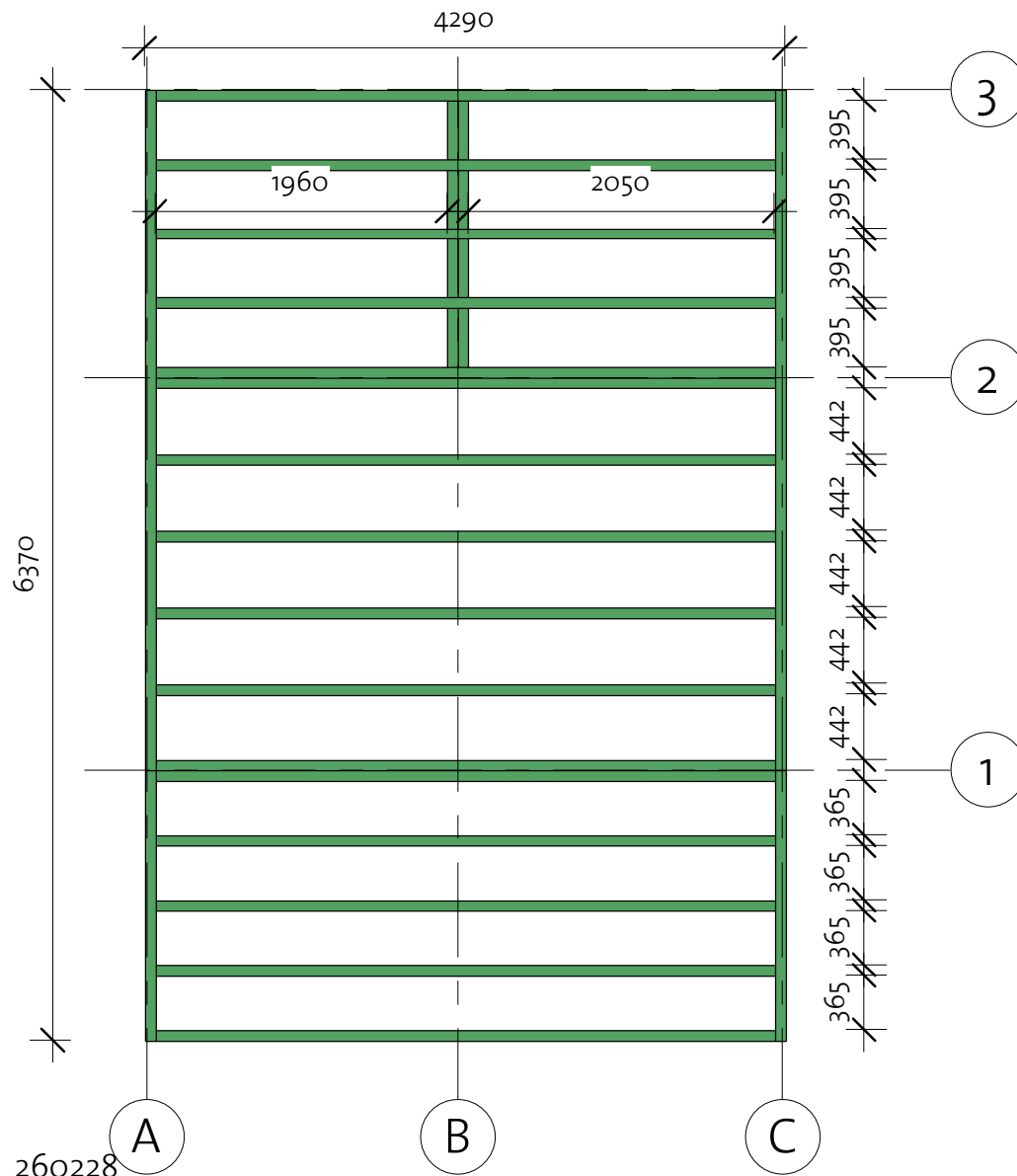
Foundation



Impregnated foundation beams				
Mark	Type	Profile	Count	Length
IFB1	IFB 70x40		2	4560
IFB2	IFB 70x40		2	1810
IFB3	IFB 70x40		16	4150
IFB4	IFB 70x40		8	395

Sauna 40 (430x460)

Floor Plan

① Baseboard

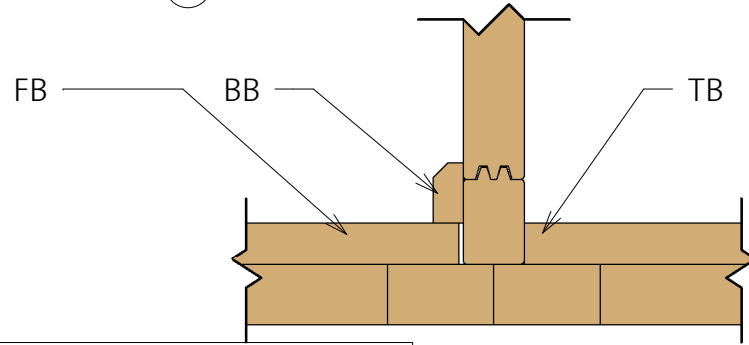

Floor Schedule

Mark	Type	Profile	Count	Length
FB1	FB 28x114		38	2584
FB2	FB 28x114		38	1882
FB3	FB 28x114		24	1929

Terrace Schedule

Mark	Type	Profile	Count	Length
TB	TB 28x120		35	1790

BB1	BB 20x40		6	4300
BB2	BB 20x40		3	4600

92203311_260228

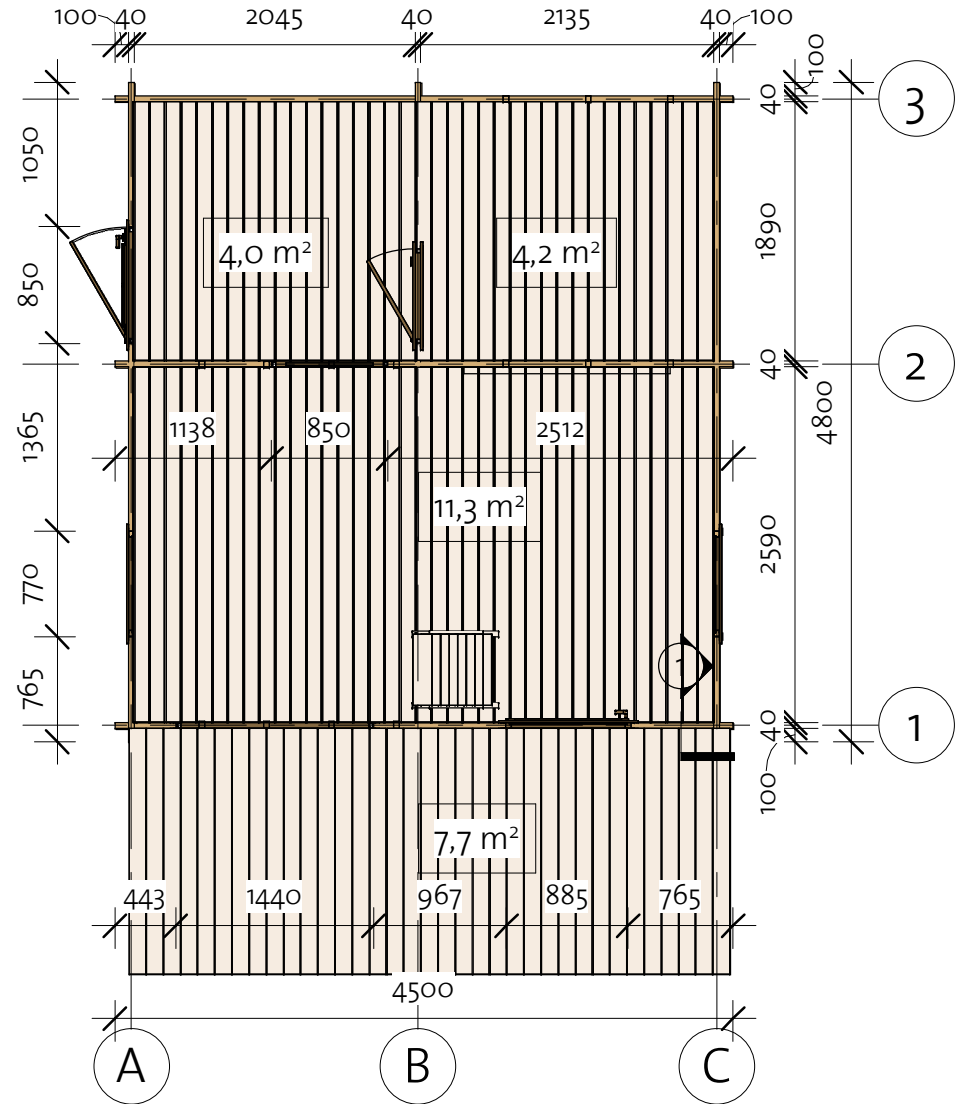

Sauna 40 (430x460)

Wall 1

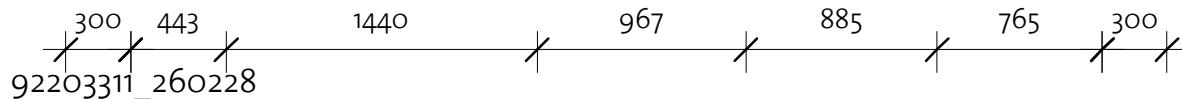
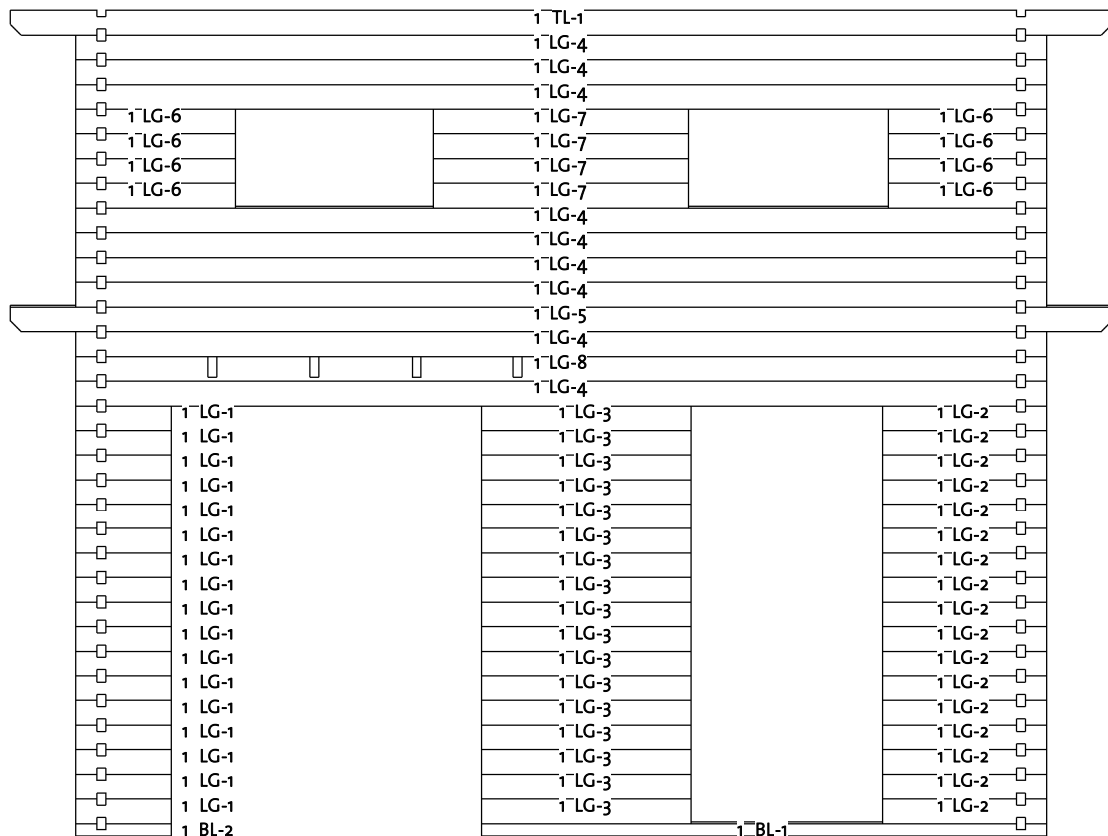
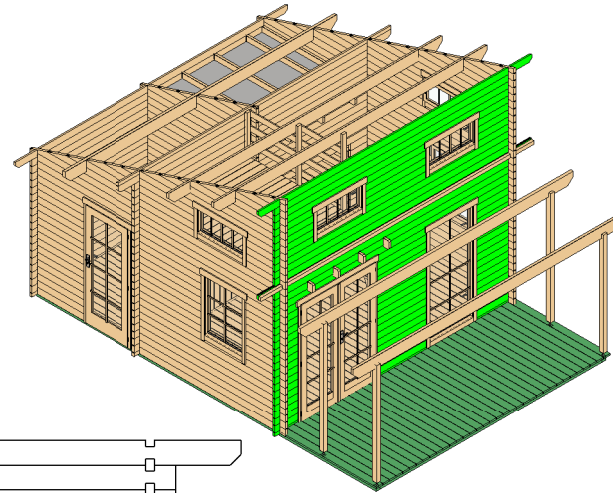

Wall 1			
Mark	Profile	Count	Cut Length

1BL-1	40X57	1	2617
1BL-2	40X57	1	443
1LG-1	40X114	17	443
1LG-2	40X114	17	765
1LG-3	40X114	17	967
1LG-4	40X114	9	4500
1LG-5	40X114	1	5100
1LG-6	40X114	8	740
1LG-7	40X114	4	1180
1LG-8	40X114	1	4500
1TL-1	40X114	1	5100

Log Profile Wall 1	
Profile	Profile

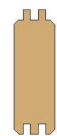
40X57	
40X114	

Log Profile Wall 1	
Profile	Profile

40X114	
--------	---

Sauna 40 (430x460)

Wall 2

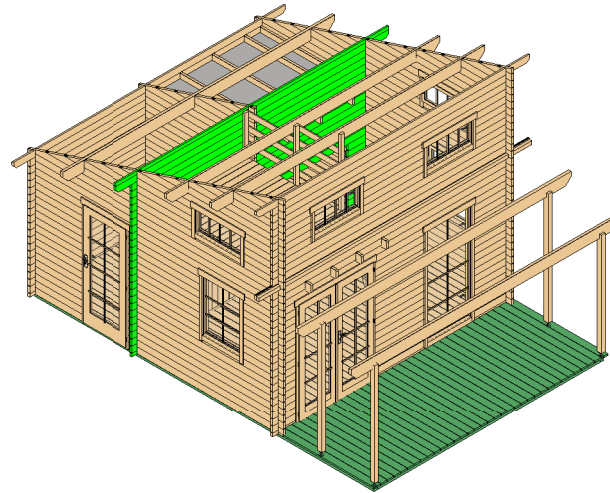

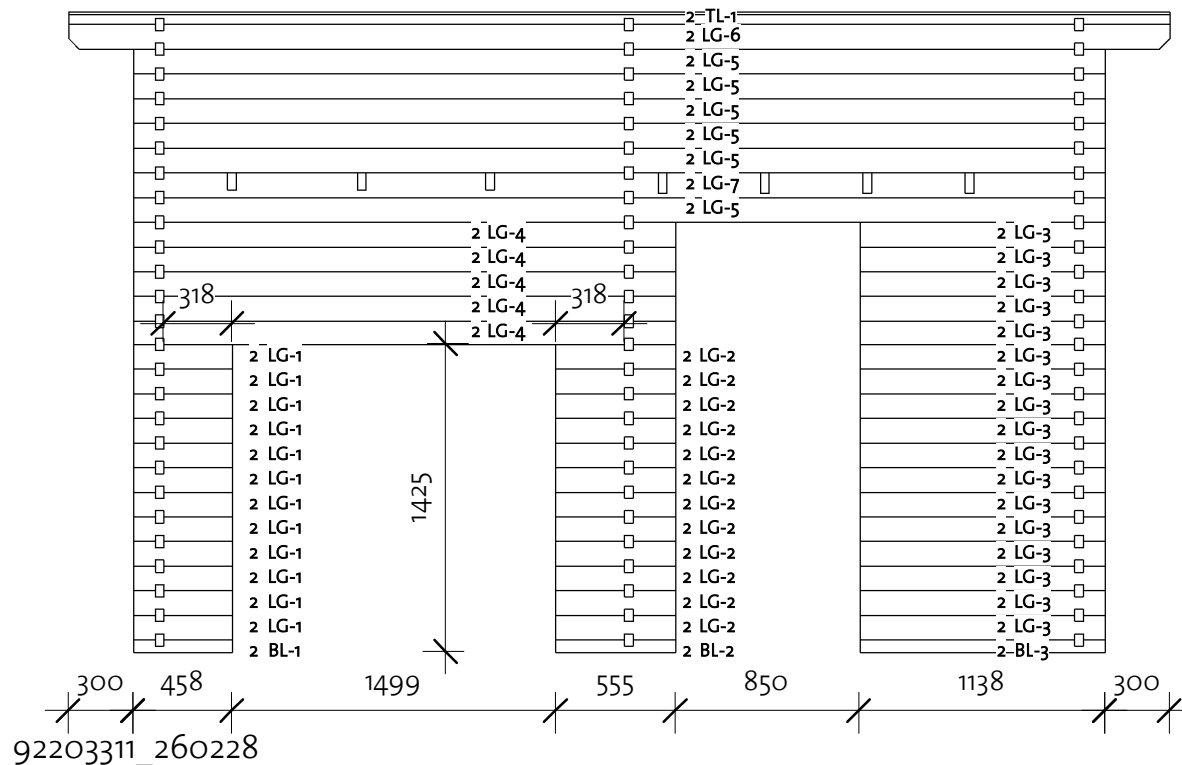

Wall 2			
Mark	Profile	Count	Cut Length

2BL-1	40x57	1	458
2BL-2	40x57	1	555
2BL-3	40x57	1	1138
2LG-1	40x114	12	458
2LG-2	40x114	12	555
2LG-3	40x114	17	1138
2LG-4	40x114	5	2512
2LG-5	40x114	6	4500
2LG-6	40x114	1	5100
2LG-7	40x114	1	4500
2TL-1	40x57	1	5100



Log Profile Wall 2	
Profile	Profile

40x57	
40x57	

Log Profile Wall 2	
Profile	Profile

40x114	
--------	---

Sauna 40 (430x460)

Wall 3

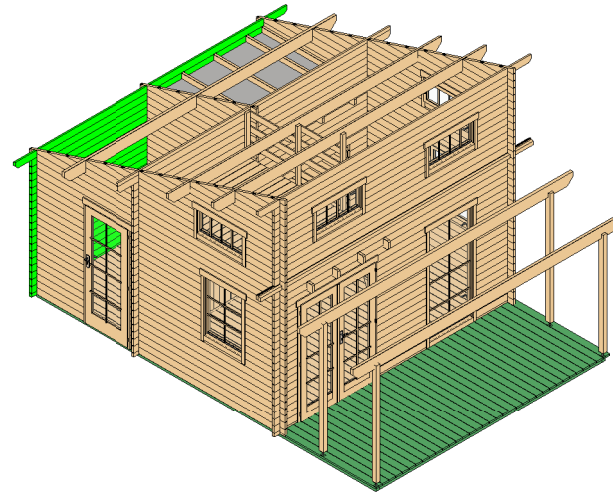

Wall 3			
Mark	Profile	Count	Cut Length

3BL-1	40x57	1	4500
3LG-1	40x114	18	4500
3LG-2	40x114	1	4500
3TL-1	40x114	1	5100

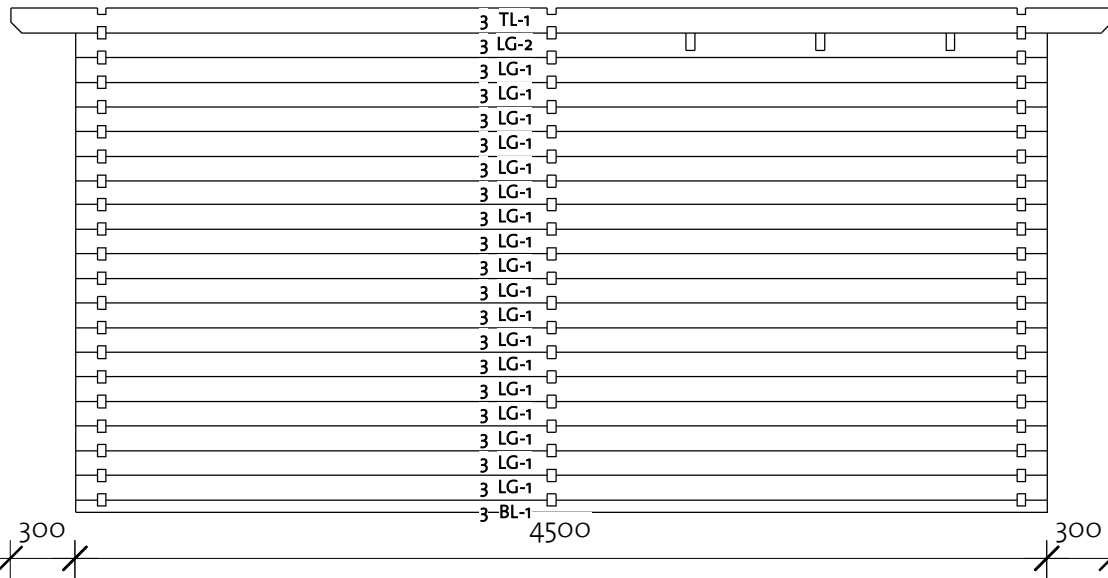

Log Profile Wall 3	
Profile	Profile

40x57	
40x114	
40x114	

92203311_260228

Sauna 40 (430x460)

Wall B

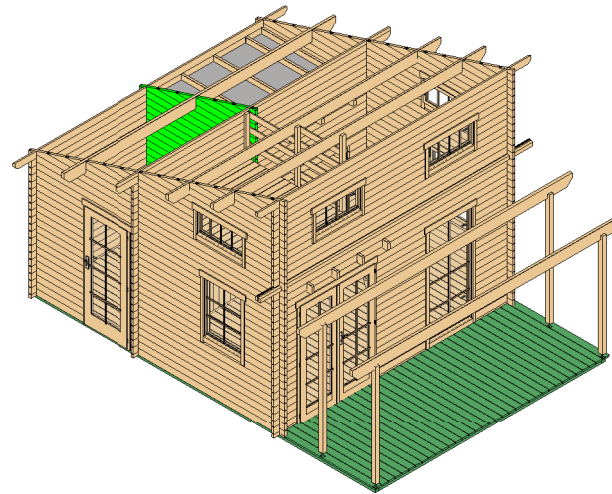

Wall B			
Mark	Profile	Count	Cut Length

BLG-1 *	40X114	1	452
BLG-2 *	40X114	1	802
BLG-3 *	40X114	1	1113
BLG-4 *	40X114	1	1504
BLG-5 *	40X114	1	1855
BLG-6 *	40X114	1	2170
BLG-7	40X114	3	2170
BLG-8	40X114	17	1210
BLG-9	40X114	17	270
BLG-10*	40X114	1	100

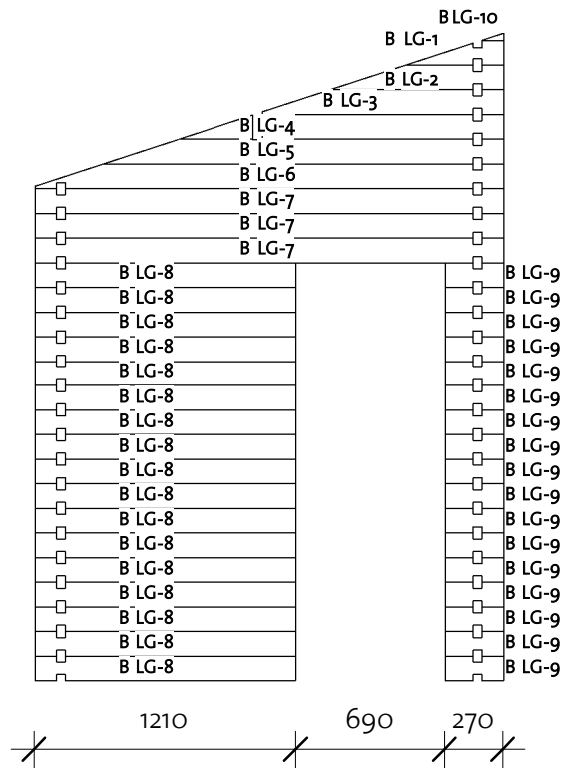

* Gable - delivered premounted

Log Profile Wall B	
Profile	Profile

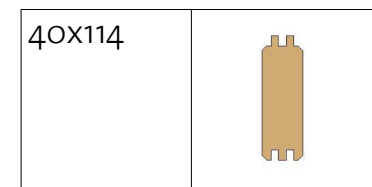

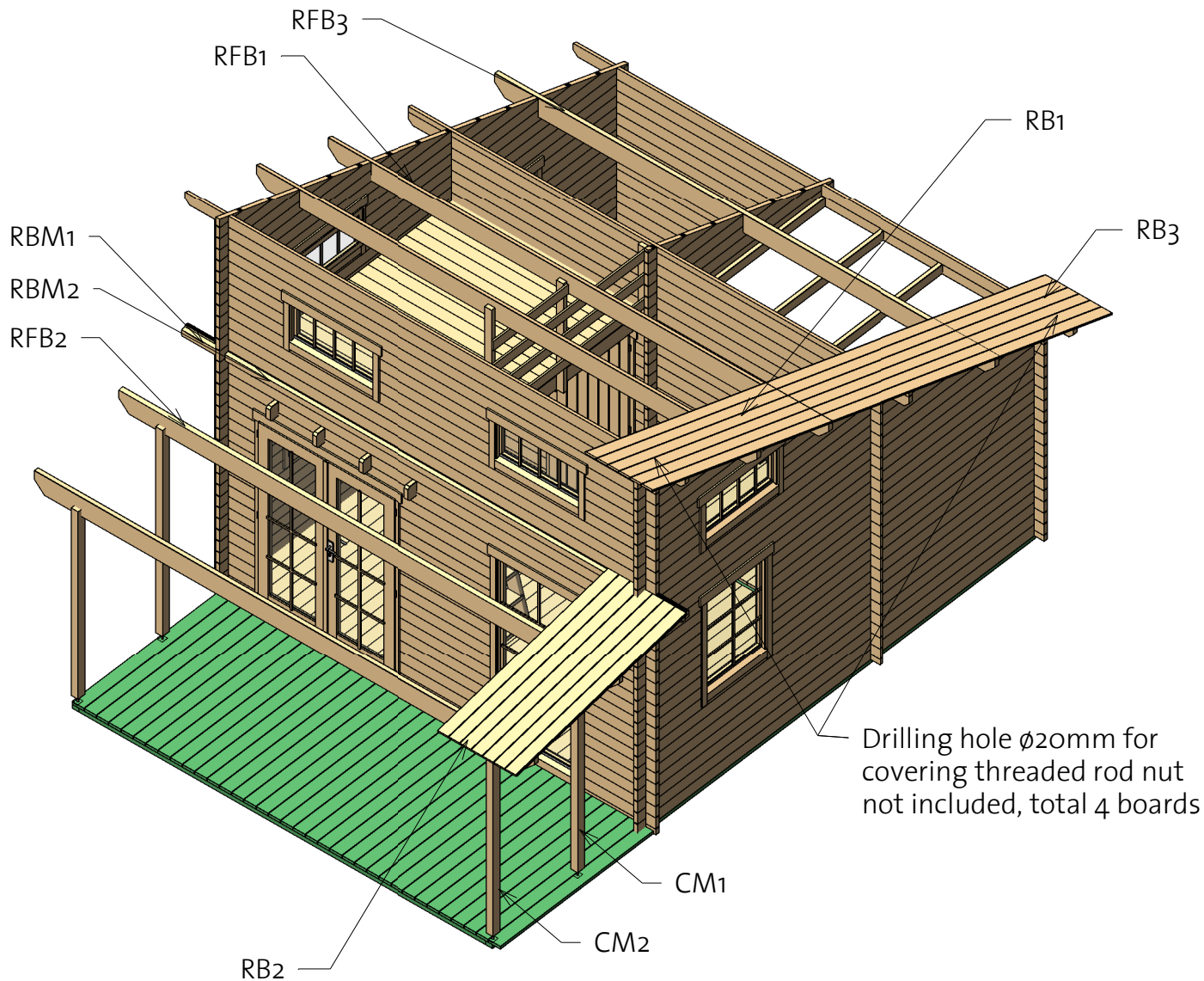

Sauna 40 (430x460)

Roof 1

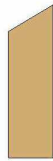

Roof				
Mark	Type	Profile	Count	Length

RB1	17x114		46	2210
RB2	17x114		46	2026
RB3	17x114		46	3461
RBM1	Beam 40x70		2	400
RBM2	Beam 40x70		1	4220
RFB1	Beam 45x195		2	5100
RFB2	Beam 45x195		2	5100
RFB3	Beam 45x195		1	5100

Column schedule

Mark	Type	Length	Count
------	------	--------	-------

CM1	Post 80x70	2094	2
CM2	Post 80x70	1920	2

92203311_260228

Sauna 40 (430x460)

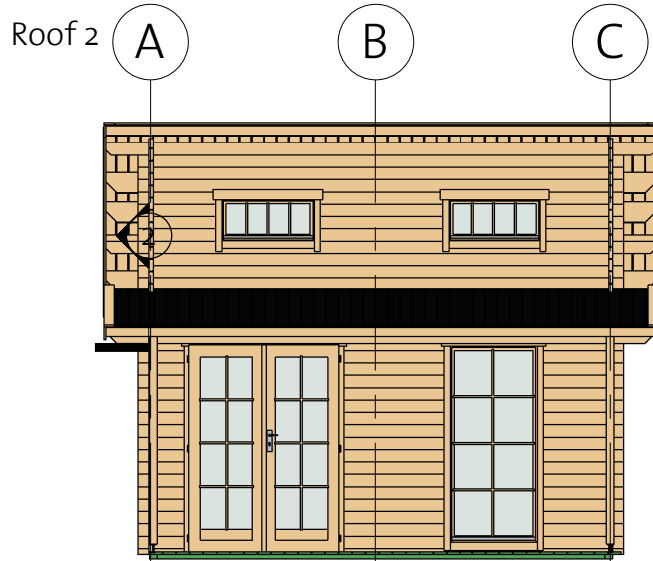



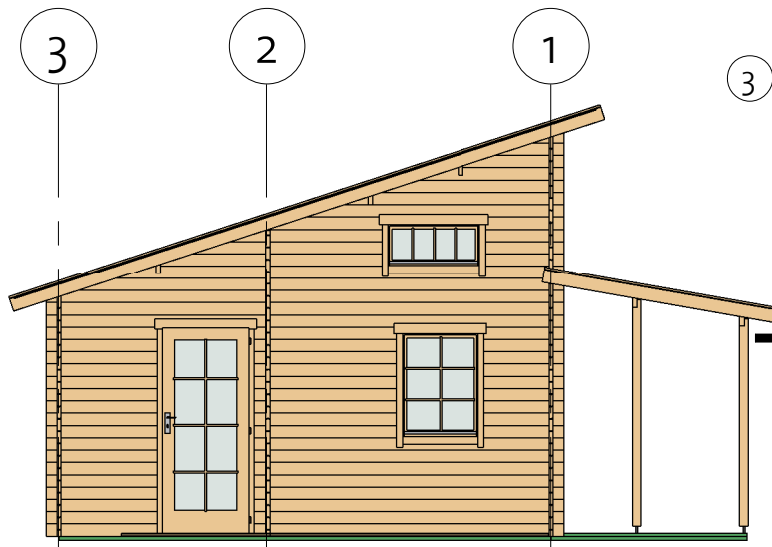
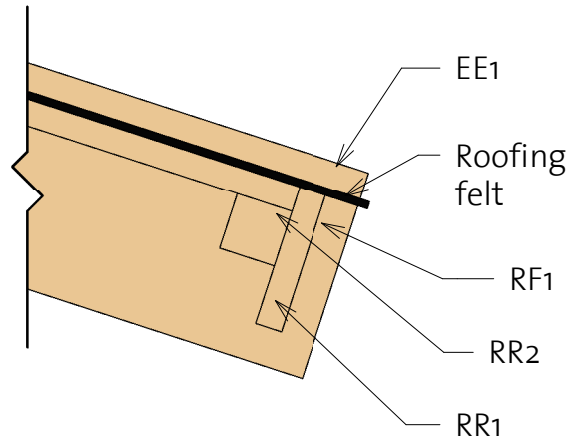

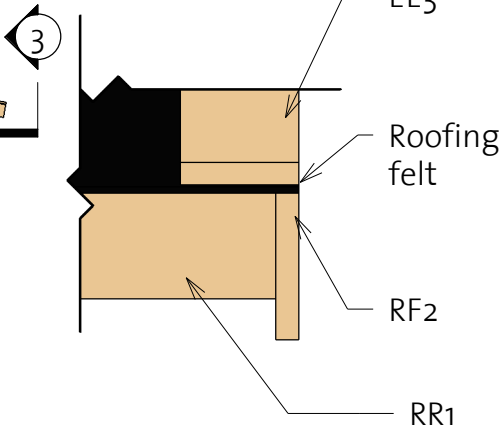

② Facia



③ Roof Reinforcement

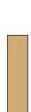

Fascia Schedule

Mark	Type	Image	Count	Length
EE1	Eave Edging 18x95		2	5759
EE2	Eave Edging 18x95		1	4932
EE3	Eave Edging 18x95		2	2178
RF1	Roof Fascia 18x120		2	5759
RF2	Roof Fascia 18x120		2	2178
RR1	Roof reinforcement 18x95		3	5100
RR2	Roof reinforcement 38x38		3	5100

Sauna 40 (430x460)

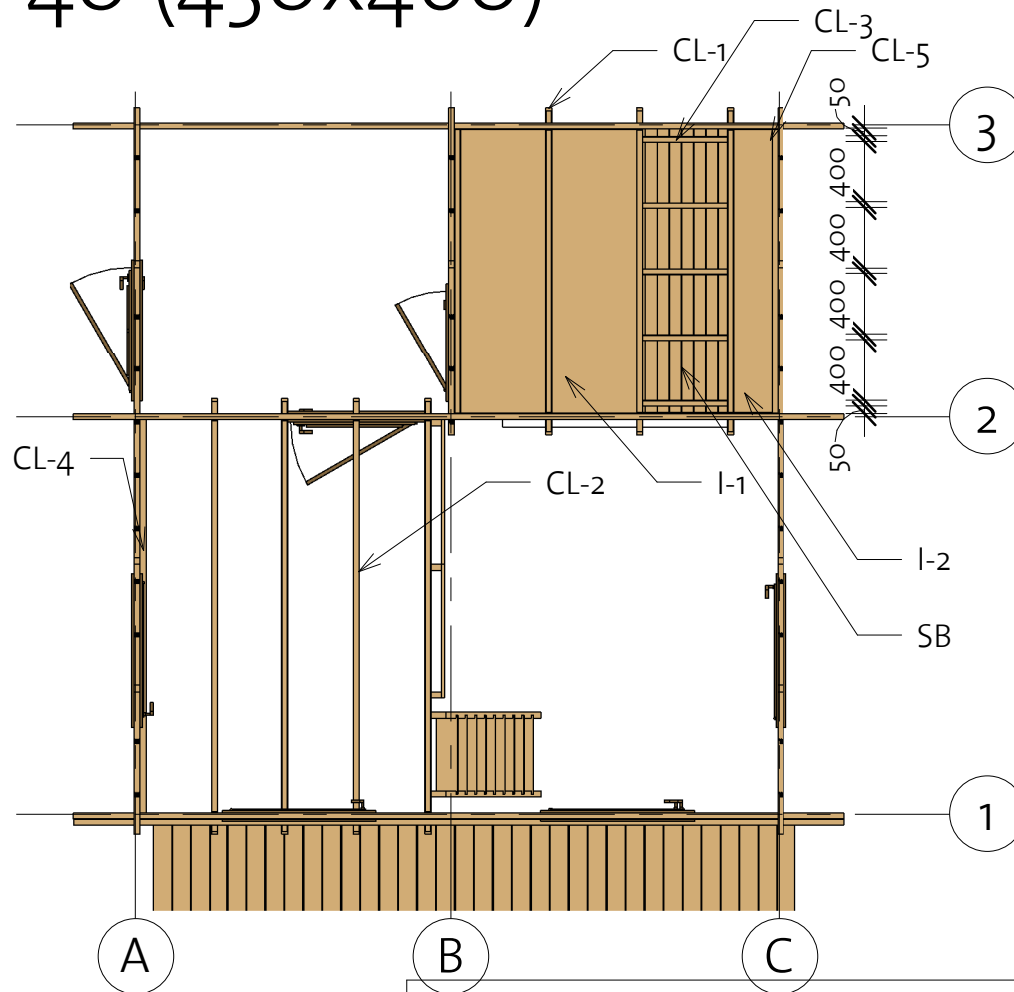

Second floor



Ceiling Schedule

Mark	Type	Profile	Count	Length
SB	15x80		27	1880

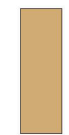
Second floor schedule

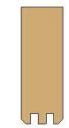
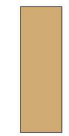
Mark	Type	Profile	Count	Length
CL-1	Ceiling beam 40x120		3	2170
CL-2	Ceiling beam 40x143		4	2870
CL-3	Batten 38x38		5	2125
CL-4	Log 40x114		1	2590
CL-5	Ceiling beam 40x120		2	1880

Insulation Schedule



Mark	Type	Count	Length
I-1	Insulation 560	3	1880
I-2	Insulation 255	1	1880

Sauna 40 (430x460)

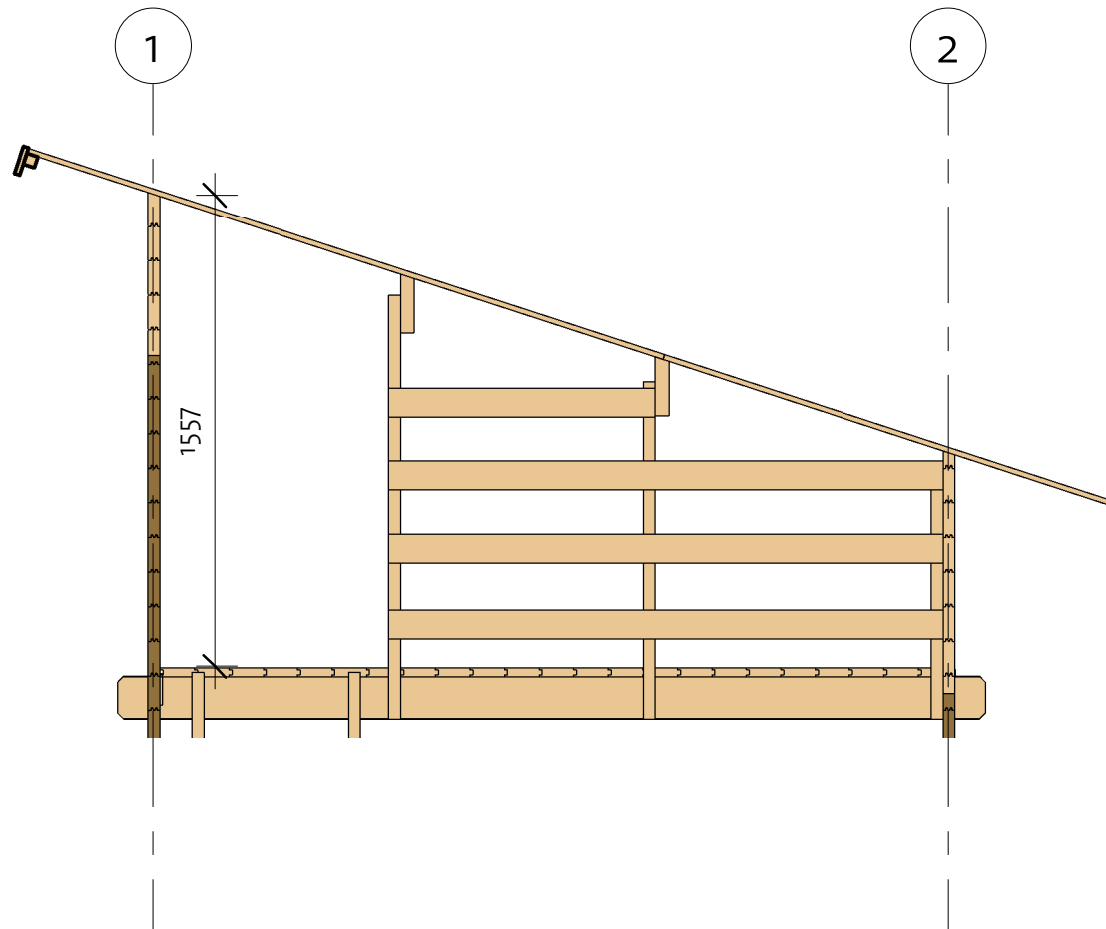
Fence







Fence schedule

Mark	Type	Profile	Count	Length
FN1	Fence 40x70		1	1397
FN2	Fence 40x70		1	1112
FN3	Fence 40x70		1	850
FN4	Fence 18x95		1	880
FN5	Fence 18x95		3	1833

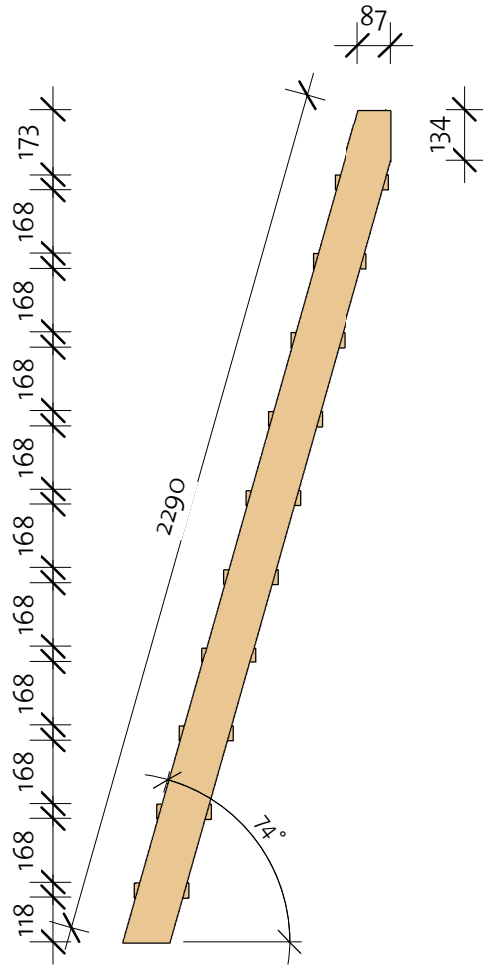
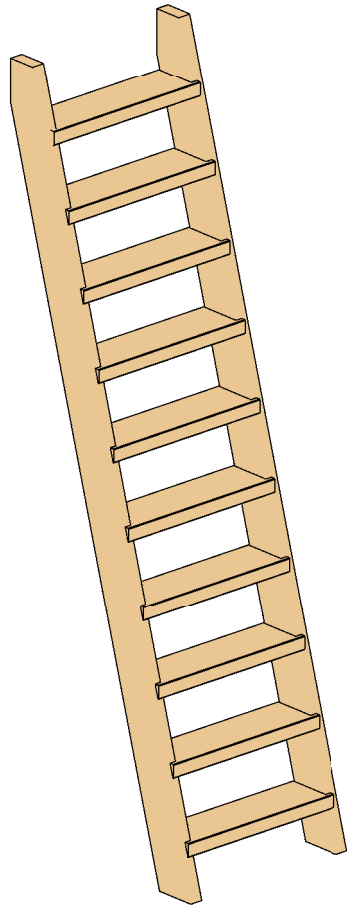
Sauna 40 (430x460)

Stairs



Stairs				
Mark	Profile	Profile	Count	Cut Length
ST1L	Stair 40X120		1	2313
ST1R	Stair 40X120		1	2313
ST2	Stair 40X143		10	520

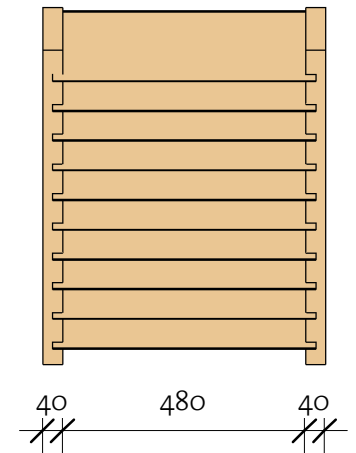
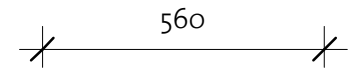

Sauna 40 (430x460)

Extras 1

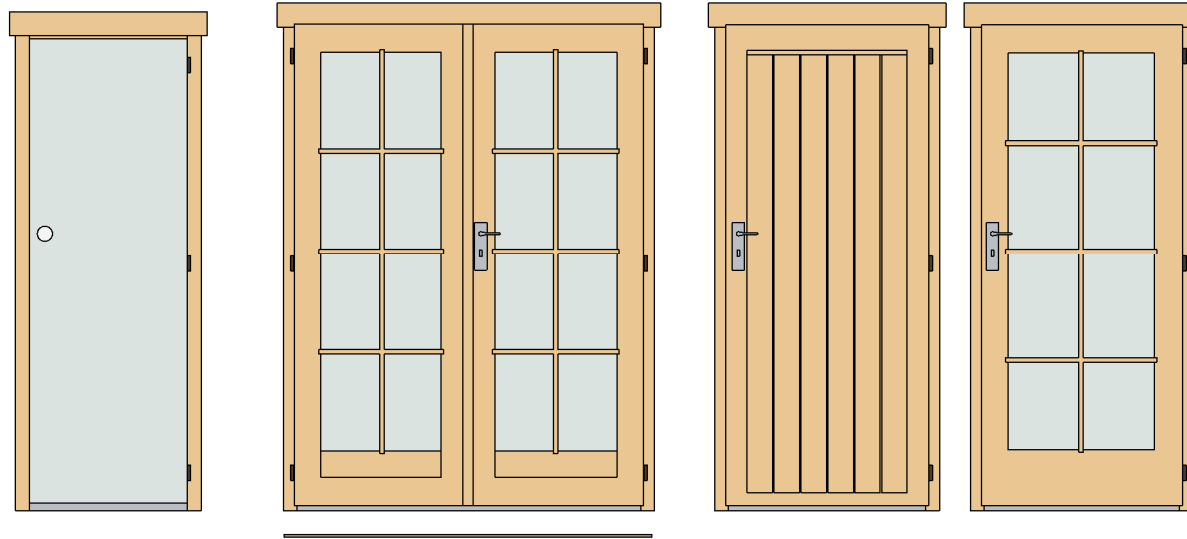

Door Schedule				
Model	Type	Width	Height	Count

SD	Sauna door	685	1920	1
CDD3R	Classic double door 3 right	1425	1955	1
CD7R	Classic door 7, wood right	840	1955	1
CD6R	Classic door 6 right	840	1955	1

Fasteners/Extras		
Name	Type	Count

Hitblock	300-400 mm	
Threaded rod \varnothing 8mm	2390mm	2
Threaded rod \varnothing 8mm	3915 mm	2
Adjustable post foot		4
Nut, washer	\varnothing 8mm	8
Nails	1,4 x 40	100
Screws	6,0 x 140	120
Screws	5,0 x 70	135
Screws	4,8 x 75	473
Screws	4,0 x 40	1320

DCB8	Door Crossbar 8 optional	--	--	3
------	--------------------------	----	----	---

DB	Door beam 1440 mm	40	12	1
----	-------------------	----	----	---

92203311_260228

Sauna 40 (430x460)

Extras 2

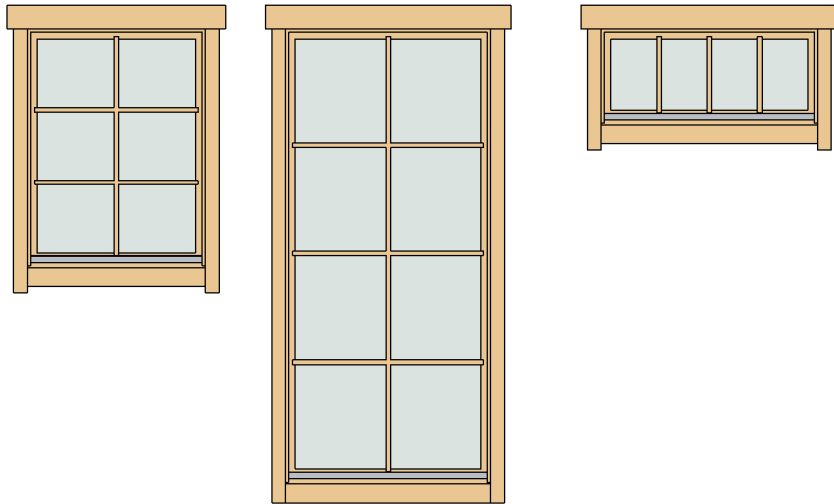

- * Windows intended for tilt opening only!
- * Fenster zur Eröffnung nur zum Kippen vorgesehen!
- * Aknad on ette nähtud ainult kaldu avamiseks!

Window Schedule				
Mark	Type	Width	Height	Count

CW1L	Classic window 1 left	765	990	1
CW1R	Classic window 1 right	765	990	1
CW4R	Classic window 4 right	875	1890	1
CW5R	Classic window 5 right	915	420	4

WCB6-1	Windows Crossbar 6-1	--	--	2
WCB8	Windows Crossbar 8	--	--	1
WCB6-2	Windows Crossbar 6-2			4

Sauna 40 (430x460)

List of all items 1

Impregnated foundation beams

Mark	Type	Profile	Count	Length
IFB1	IFB 70x40		2	4560
IFB2	IFB 70x40		2	1810
IFB3	IFB 70x40		16	4150
IFB4	IFB 70x40		8	395

BB1	BB 20x40		6	4300
BB2	BB 20x40		3	4600

Column schedule

Mark	Type	Length	Count
CM1	Post 80x70	2094	2
CM2	Post 80x70	1920	2

Insulation Schedule

Mark	Type	Count	Length
I-1	Insulation 560	3	1880
I-2	Insulation 255	1	1880





Terrace Schedule

Mark	Type	Profile	Count	Length
TB	TB 28x120		35	1790

Floor Schedule

Mark	Type	Profile	Count	Length
FB1	FB 28x114		38	2584
FB2	FB 28x114		38	1882
FB3	FB 28x114		24	1929

Fascia Schedule



Mark	Type	Image	Count	Length
EE1	Eave Edging 18x95		2	5759
EE2	Eave Edging 18x95		1	4932
EE3	Eave Edging 18x95		2	2178
RF1	Roof Fascia 18x120		2	5759
RF2	Roof Fascia 18x120		2	2178
RR1	Roof reinforcement 18x95		3	5100
RR2	Roof reinforcement 38x38		3	5100

92203311_260228

Sauna 40 (430x460)

List of all items 2





Roof				
Mark	Type	Profile	Count	Length

RB1	17x114		46	2210
RB2	17x114		46	2026
RB3	17x114		46	3461
RBM1	Beam 40x70		2	400
RBM2	Beam 40x70		1	4220
RFB1	Beam 45x195		2	5100
RFB2	Beam 45x195		2	5100
RFB3	Beam 45x195		1	5100



Ceiling Schedule				
Mark	Type	Profile	Count	Length

SB	15x80		27	1880
----	-------	---	----	------

Second floor schedule				
Mark	Type	Profile	Count	Length



CL-1	Ceiling beam 40x120		3	2170
CL-2	Ceiling beam 40x143		4	2870
CL-3	Batten 38x38		5	2125
CL-4	Log 40x114		1	2590
CL-5	Ceiling beam 40x120		2	1880

Fence schedule				
Mark	Type	Profile	Count	Length

FN1	Fence 40x70		1	1397
FN2	Fence 40x70		1	1112
FN3	Fence 40x70		1	850
FN4	Fence 18x95		1	880
FN5	Fence 18x95		3	1833

Sauna 40 (430x460)

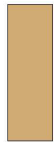
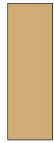
List of all items 3

Stair				
Mark	Profile	Profile	Count	Cut Length
ST1L	Stair 40x120		1	2333
ST1R	Stair 40x120		1	2333
ST2	Stair 40x143		9	520

Wall 3			
Mark	Profile	Count	Cut Length

3BL-1	40x57	1	4500
3LG-1	40x114	18	4500
3LG-2	40x114	1	4500
3TL-1	40x114	1	5100

Wall 1			
Mark	Profile	Count	Cut Length
1BL-1	40x57	1	2617
1BL-2	40x57	1	443
1LG-1	40x114	17	443
1LG-2	40x114	17	765
1LG-3	40x114	17	967
1LG-4	40x114	9	4500
1LG-5	40x114	1	5100
1LG-6	40x114	8	740
1LG-7	40x114	4	1180
1LG-8	40x114	1	4500
1TL-1	40x114	1	5100

Wall 2			
Mark	Profile	Count	Cut Length

2BL-1	40x57	1	458
2BL-2	40x57	1	555
2BL-3	40x57	1	1138
2LG-1	40x114	12	458
2LG-2	40x114	12	555
2LG-3	40x114	17	1138
2LG-4	40x114	5	2512
2LG-5	40x114	6	4500
2LG-6	40x114	1	5100
2LG-7	40x114	1	4500
2TL-1	40x57	1	5100

Sauna 40 (430x460)

List of all items 4

Wall A			
Mark	Profile	Count	Cut Length

ALG-1 *	40X114	1	275
ALG-2 *	40X114	1	626
ALG-3 *	40X114	1	937
ALG-4 *	40X114	1	1328
ALG-5 *	40X114	1	1678
ALG-6 *	40X114	1	2029
ALG-7 *	40X114	1	2380
ALG-8 *	40X114	1	2730
ALG-9 *	40X114	4	750
ALG-10*	40X114	1	1412
ALG-11 *	40X114	1	1762
ALG-12*	40X114	1	2073
ALG-13*	40X114	1	2464
ALG-14*	40X114	1	4485
ALG-15*	40X114	1	4800
ALG-16	40X114	3	4800
ALG-17	40X114	9	1365
ALG-18	40X114	9	765
ALG-19	40X114	8	2900
ALG-20	40X114	17	1050

* Gable - delivered premounted

Wall B			
Mark	Profile	Count	Cut Length

BLG-1 *	40X114	1	452
BLG-2 *	40X114	1	802
BLG-3 *	40X114	1	1113
BLG-4 *	40X114	1	1504
BLG-5 *	40X114	1	1855
BLG-6 *	40X114	1	2170
BLG-7	40X114	3	2170
BLG-8	40X114	17	1210
BLG-9	40X114	17	270
BLG-10*	40X114	1	100



Wall C			
Mark	Profile	Count	Cut Length

CLG-1 *	40X114	1	275
CLG-2 *	40X114	1	626
CLG-3 *	40X114	1	937
CLG-4 *	40X114	1	1328
CLG-5 *	40X114	1	1678
CLG-6 *	40X114	1	2029
CLG-7 *	40X114	1	2380
CLG-8 *	40X114	1	2730
CLG-9 *	40X114	4	750
CLG-10*	40X114	1	1412
CLG-11 *	40X114	1	1762
CLG-12*	40X114	1	2073
CLG-13*	40X114	1	2464
CLG-14*	40X114	1	4485
CLG-15*	40X114	1	4800
CLG-16	40X114	11	4800
CLG-17	40X114	9	3265
CLG-18	40X114	9	765

Sauna 40 (430x460)

List of all items 5

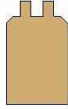
Log profiles	
Profile	Profile

40x57	
40x114	
40x114	
40x57	