

# Sauna 40 (430x460)

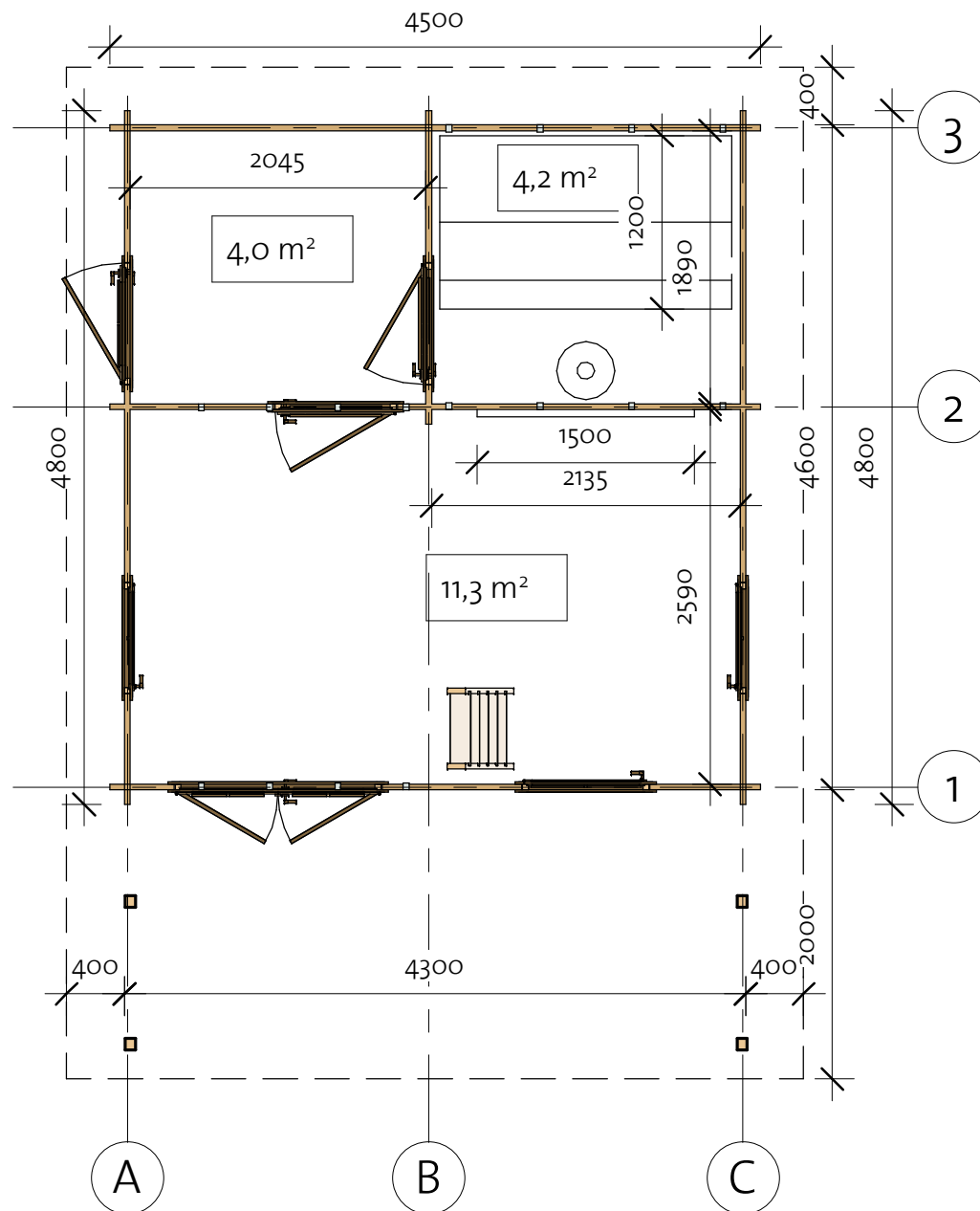

92203311\_220405



# Sauna 40 (430x460)

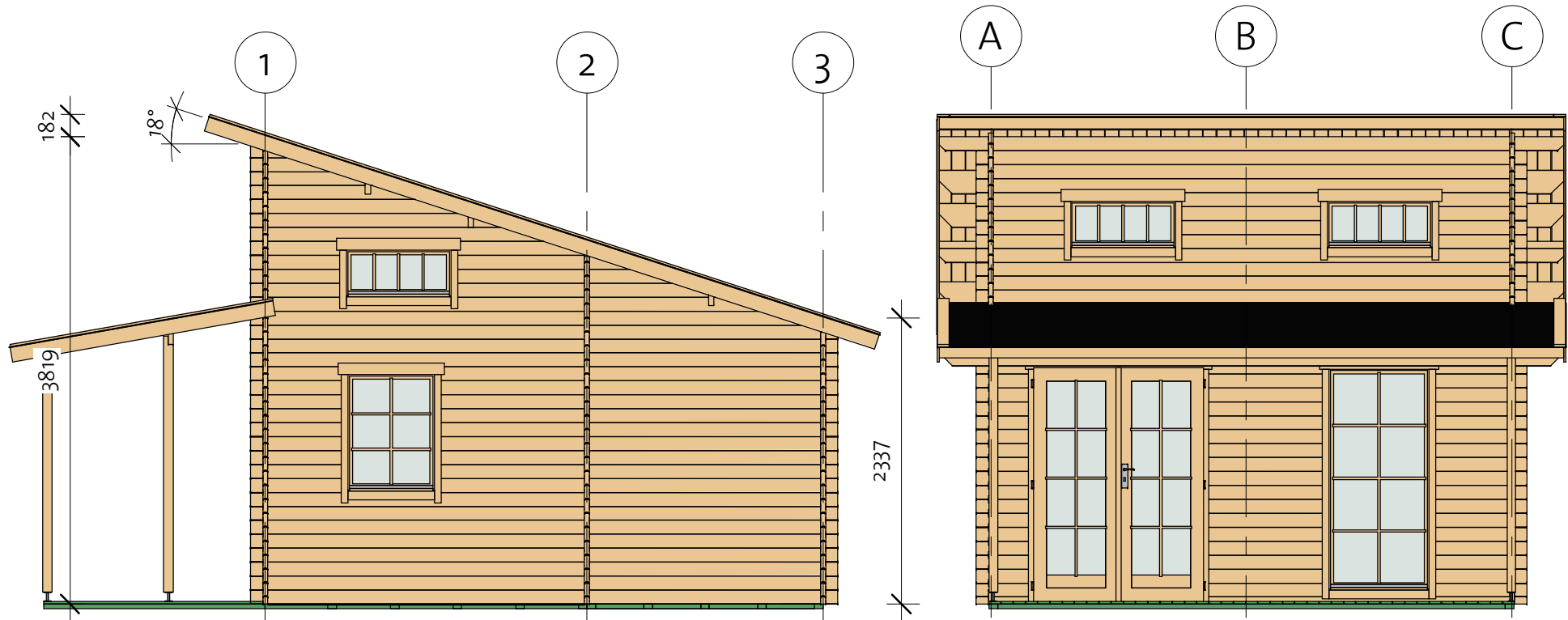

92203311\_220405

 **VIKTRÄ**

# Sauna 40 (430x460)



# Sauna 40 (430x460)

Foundation

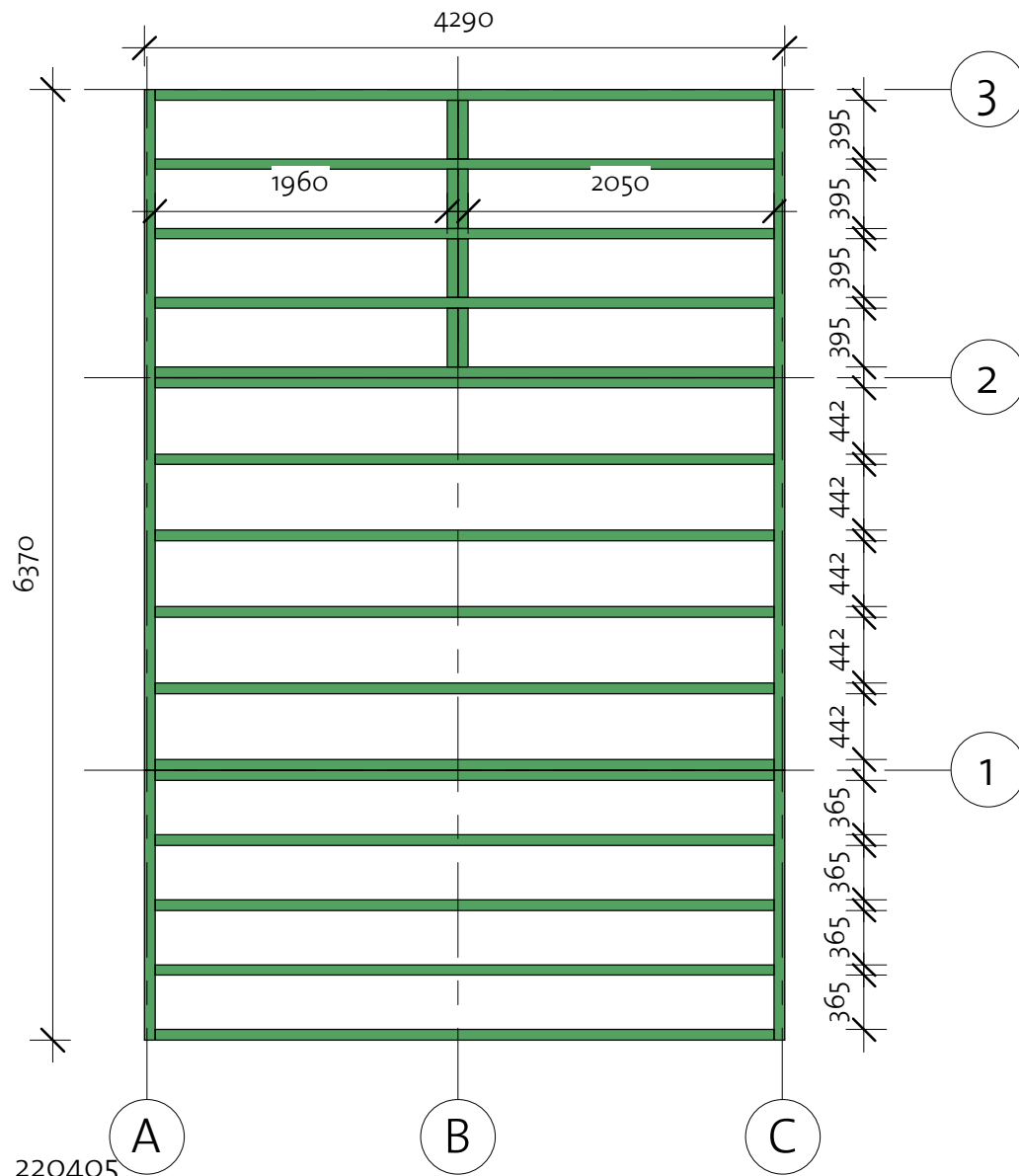

Impregnated foundation beams				
Mark	Type	Profile	Count	Length

IFB1	IFB 70x40		2	4560
IFB2	IFB 70x40		2	1810
IFB3	IFB 70x40		16	4150
IFB4	IFB 70x40		8	395

# Sauna 40 (430x460)

Floor Plan

① Baseboard

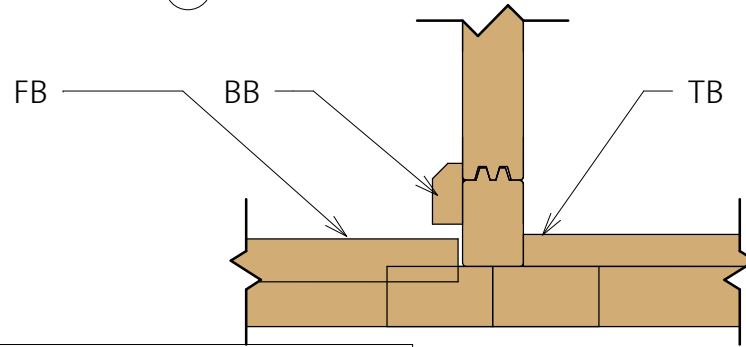

Floor Schedule

Mark	Type	Profile	Count	Length
------	------	---------	-------	--------

FB1	FB 28x114		38	2584
FB2	FB 28x114		38	1882
FB3	FB 28x114		24	1929

Terrace Schedule

Mark	Type	Profile	Count	Length
------	------	---------	-------	--------

TB	TB 21x95		45	1790
----	-------------	--	----	------

92203311\_220405

BB1	BB 20x40		6	4300
BB2	BB 20x40		3	4600

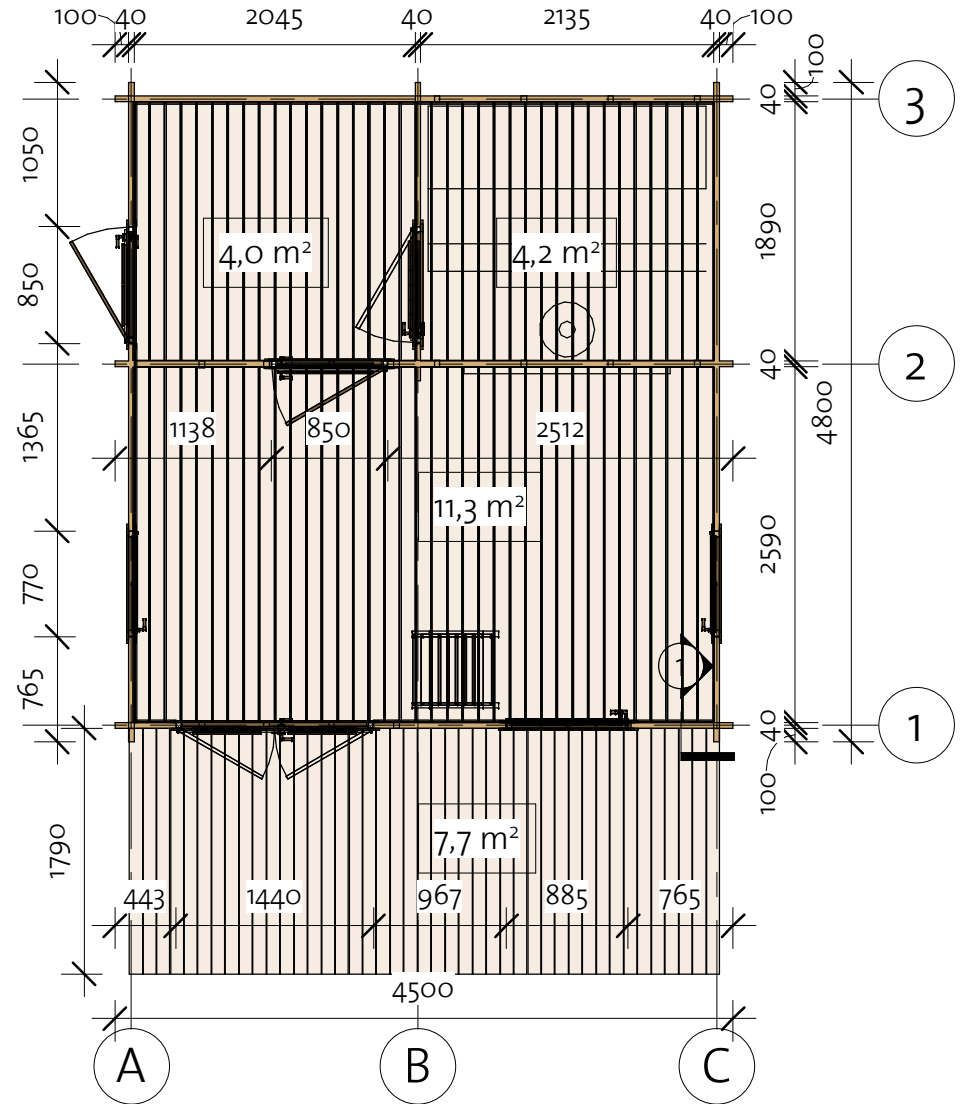

Sauna schedule

Type	Count
------	-------

Sauna board pack	1
Sauna bench pack	1

# Sauna 40 (430x460)

Wall 1

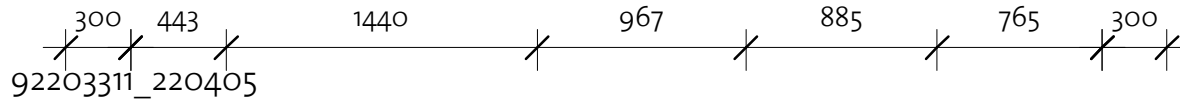
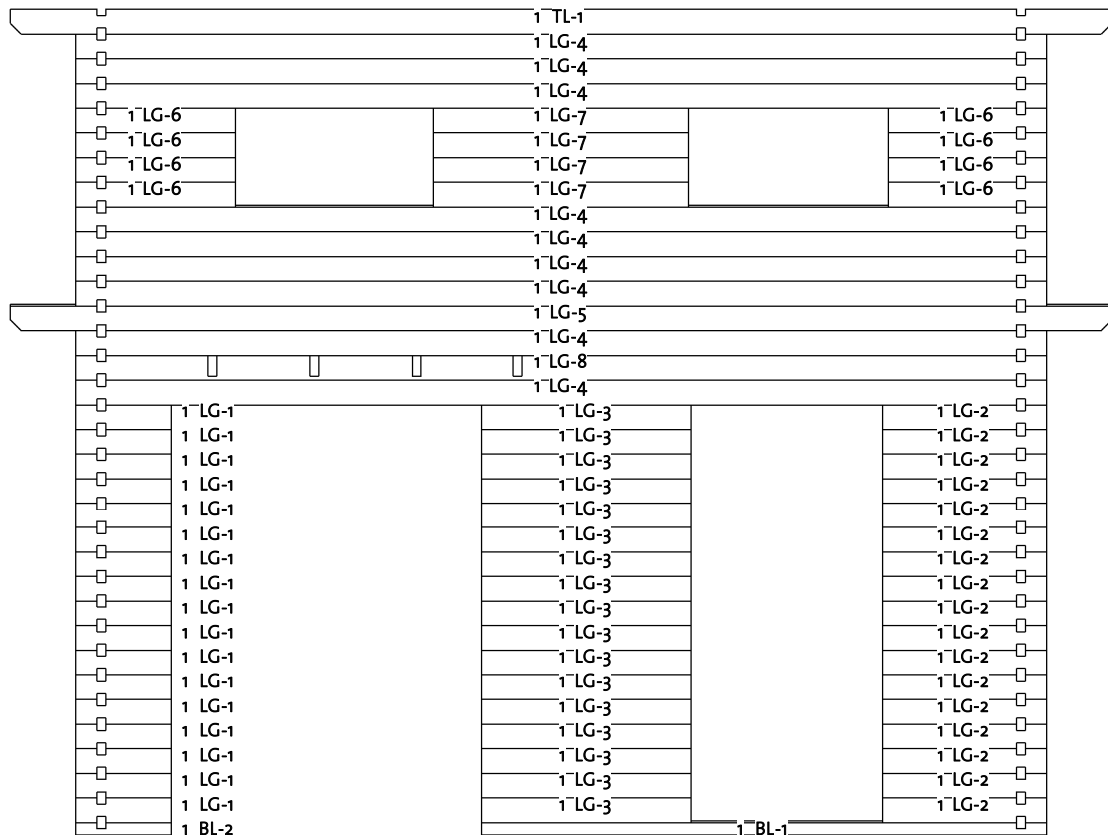
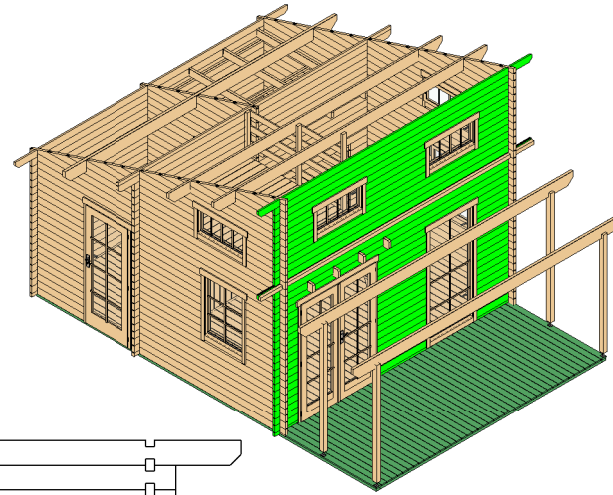

Wall 1			
Mark	Profile	Count	Cut Length

1BL-1	40X57	1	2617
1BL-2	40X57	1	443
1LG-1	40X114	17	443
1LG-2	40X114	17	765
1LG-3	40X114	17	967
1LG-4	40X114	9	4500
1LG-5	40X114	1	5100
1LG-6	40X114	8	740
1LG-7	40X114	4	1180
1LG-8	40X114	1	4500
1TL-1	40X114	1	5100

Log Profile Wall 1	
Profile	Profile

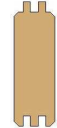
40X57	
40X114	

Log Profile Wall 1	
Profile	Profile

40X114	
--------	---

# Sauna 40 (430x460)

Wall 2

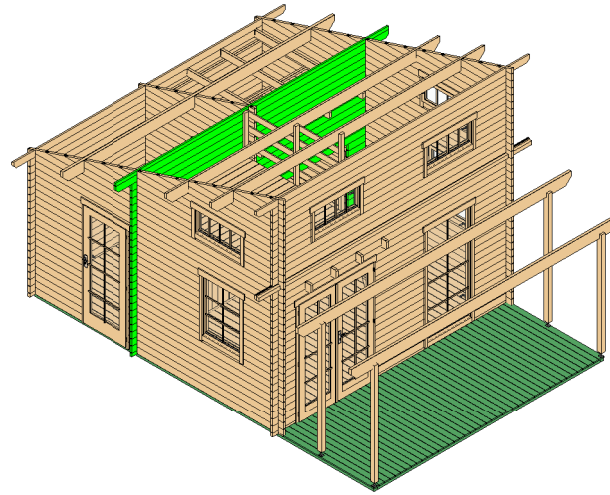

Wall 2			
Mark	Profile	Count	Cut Length

2BL-1	40X57	1	458
2BL-2	40X57	1	555
2BL-3	40X57	1	1138
2LG-1	40X114	12	458
2LG-2	40X114	12	555
2LG-3	40X114	17	1138
2LG-4	40X114	5	2512
2LG-5	40X114	6	4500
2LG-6	40X114	1	5100
2LG-7	40X114	1	4500
2TL-1	40X57	1	5100

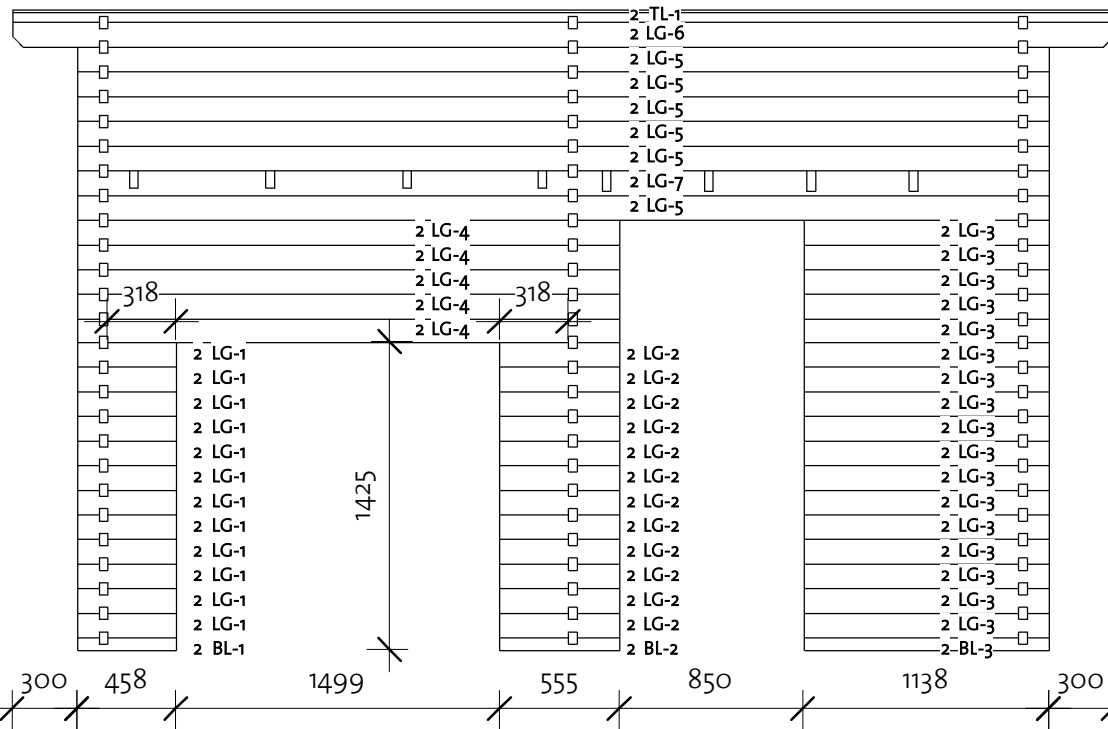

92203311\_220405

Log Profile Wall 2	
Profile	Profile

40X57	
40X57	

Log Profile Wall 2	
Profile	Profile

40X114	
--------	--

# Sauna 40 (430x460)

Wall 3

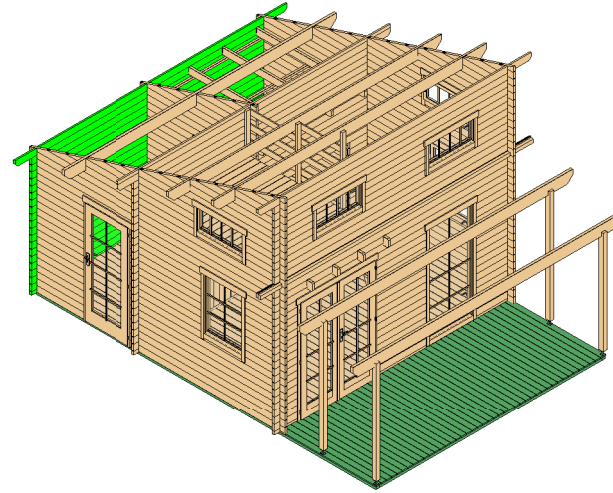

Wall 3			
Mark	Profile	Count	Cut Length

3BL-1	40x57	1	4500
3LG-1	40x114	18	4500
3LG-2	40x114	1	4500
3TL-1	40x114	1	5100

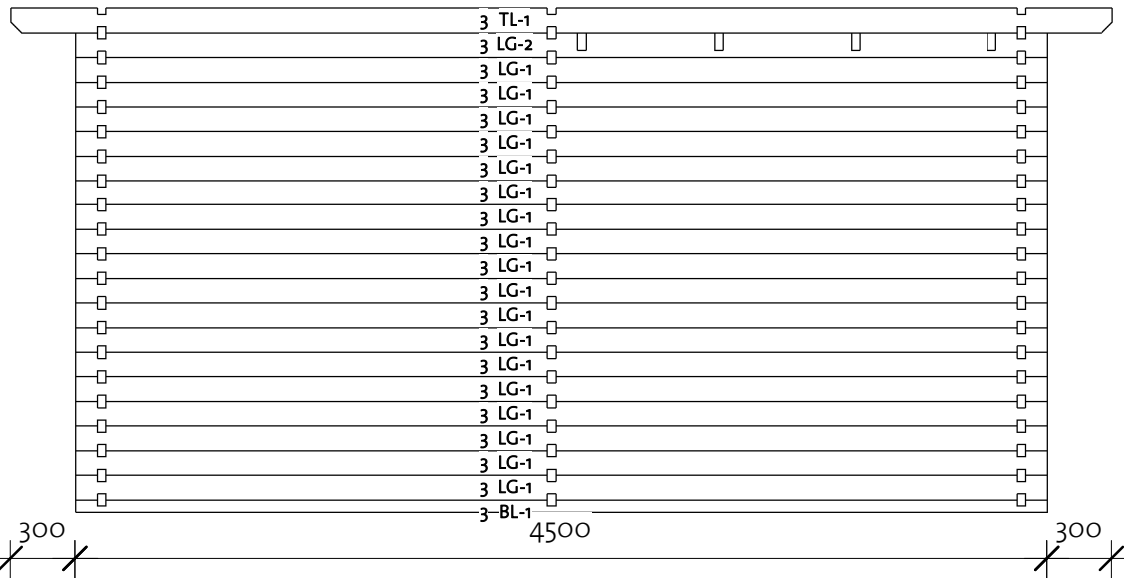

Log Profile Wall 3	
Profile	Profile

40x57	
40x114	
40x114	

92203311\_220405



# Sauna 40 (430x460)

Wall A

Log Profile Wall A	
Profile	Profile

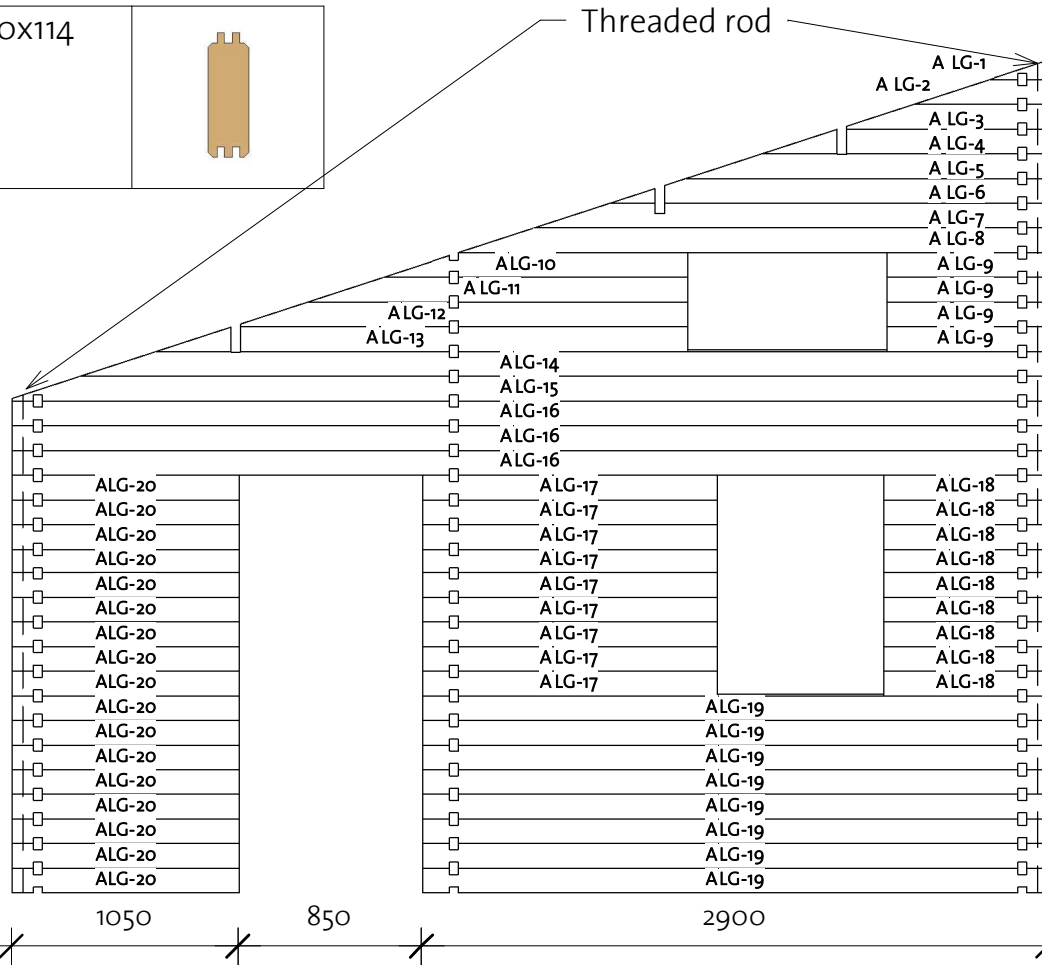
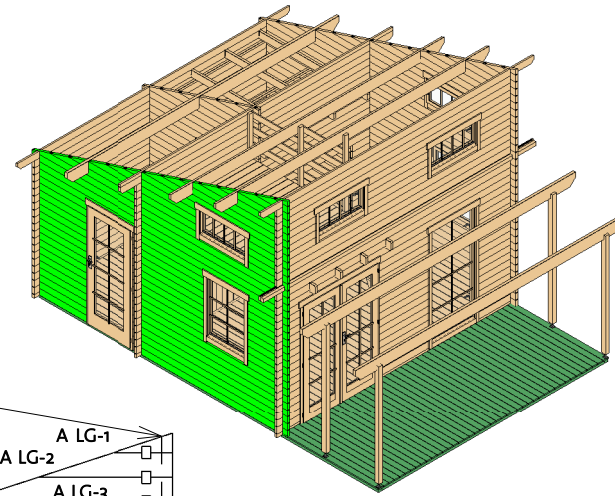
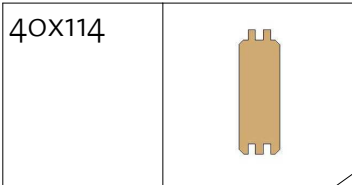

Wall A			
Mark	Profile	Count	Cut Length

ALG-1 *	40X114	1	275
ALG-2 *	40X114	1	626
ALG-3 *	40X114	1	937
ALG-4 *	40X114	1	1328
ALG-5 *	40X114	1	1678
ALG-6 *	40X114	1	2029
ALG-7 *	40X114	1	2380
ALG-8 *	40X114	1	2730
ALG-9 *	40X114	4	750
ALG-10 *	40X114	1	1412
ALG-11 *	40X114	1	1762
ALG-12 *	40X114	1	2073
ALG-13 *	40X114	1	2464
ALG-14 *	40X114	1	4485
ALG-15 *	40X114	1	4800
ALG-16	40X114	3	4800
ALG-17	40X114	9	1365
ALG-18	40X114	9	765
ALG-19	40X114	8	2900
ALG-20	40X114	17	1050

\* Gable - delivered premounted

# Sauna 40 (430x460)

Wall B

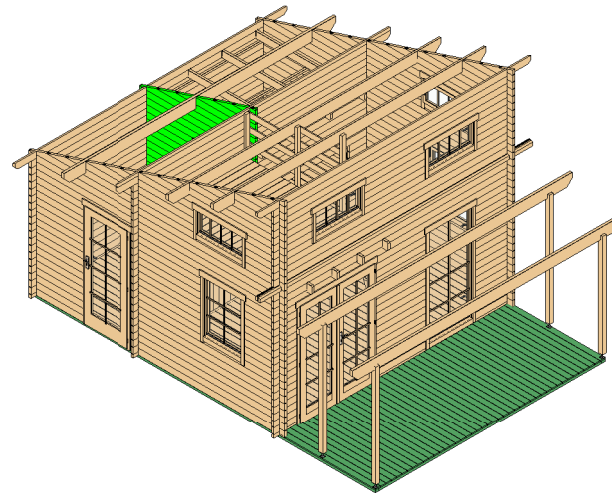

Wall B			
Mark	Profile	Count	Cut Length

BLG-1 *	40X114	1	452
BLG-2 *	40X114	1	802
BLG-3 *	40X114	1	1113
BLG-4 *	40X114	1	1504
BLG-5 *	40X114	1	1855
BLG-6 *	40X114	1	2170
BLG-7	40X114	3	2170
BLG-8	40X114	17	1050
BLG-9	40X114	17	270
BLG-10*	40X114	1	100

\* Gable - delivered premounted

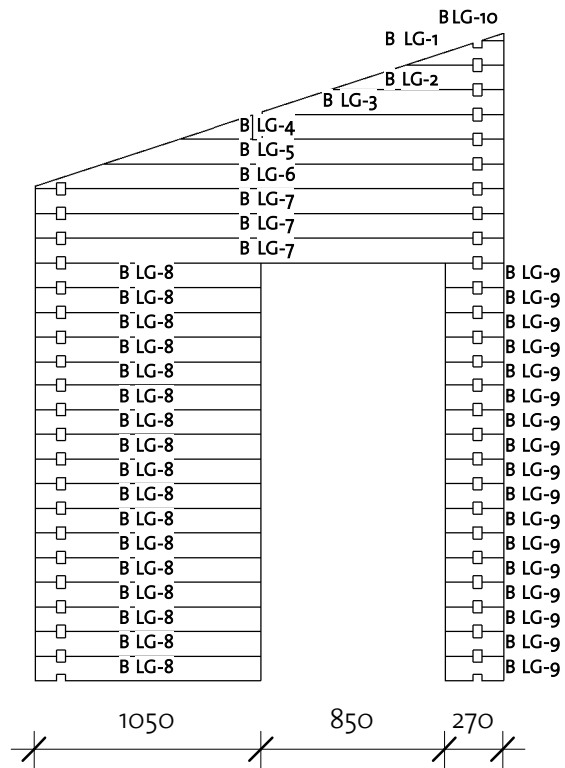

Log Profile Wall B	
Profile	Profile

40X114	
--------	--

# Sauna 40 (430x460)

Wall C

Log Profile Wall C	
Profile	Profile

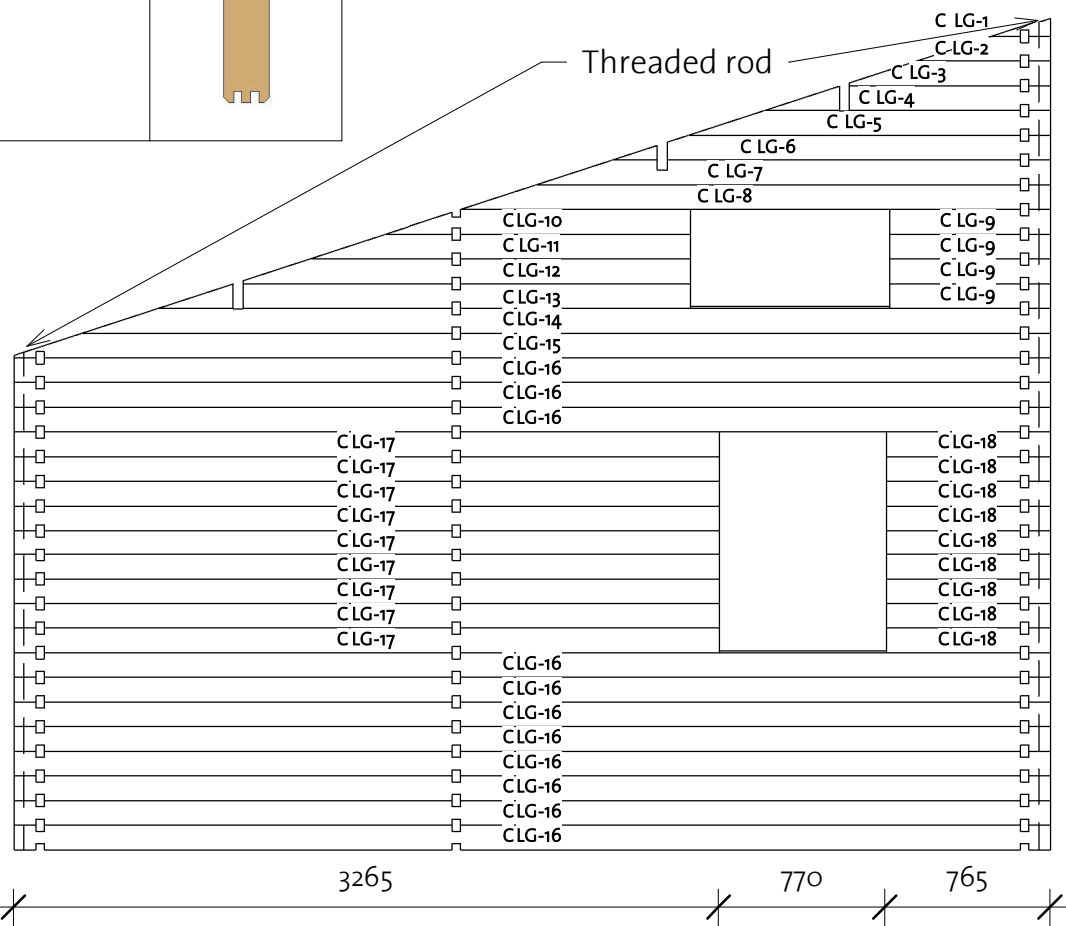
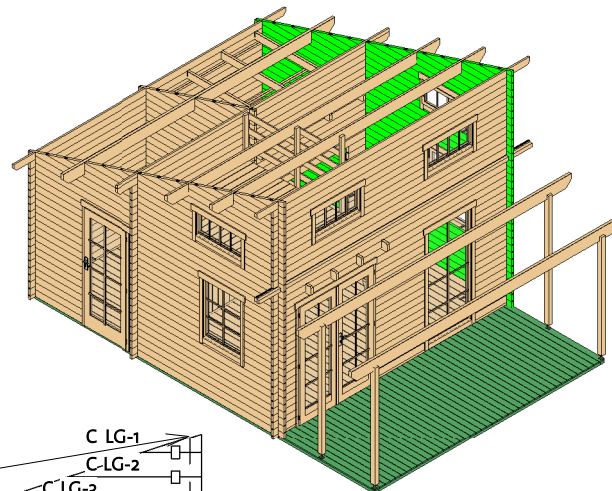
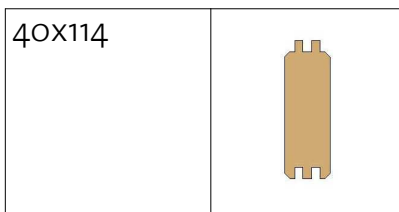

Wall C			
Mark	Profile	Count	Cut Length

CLG-1 *	40X114	1	275
CLG-2 *	40X114	1	626
CLG-3 *	40X114	1	937
CLG-4 *	40X114	1	1328
CLG-5 *	40X114	1	1678
CLG-6 *	40X114	1	2029
CLG-7 *	40X114	1	2380
CLG-8 *	40X114	1	2730
CLG-9 *	40X114	4	750
CLG-10 *	40X114	1	1412
CLG-11 *	40X114	1	1762
CLG-12 *	40X114	1	2073
CLG-13 *	40X114	1	2464
CLG-14 *	40X114	1	4485
CLG-15 *	40X114	1	4800
CLG-16	40X114	11	4800
CLG-17	40X114	9	3265
CLG-18	40X114	9	765



\* Gable - delivered premounted

# Sauna 40 (430x460)

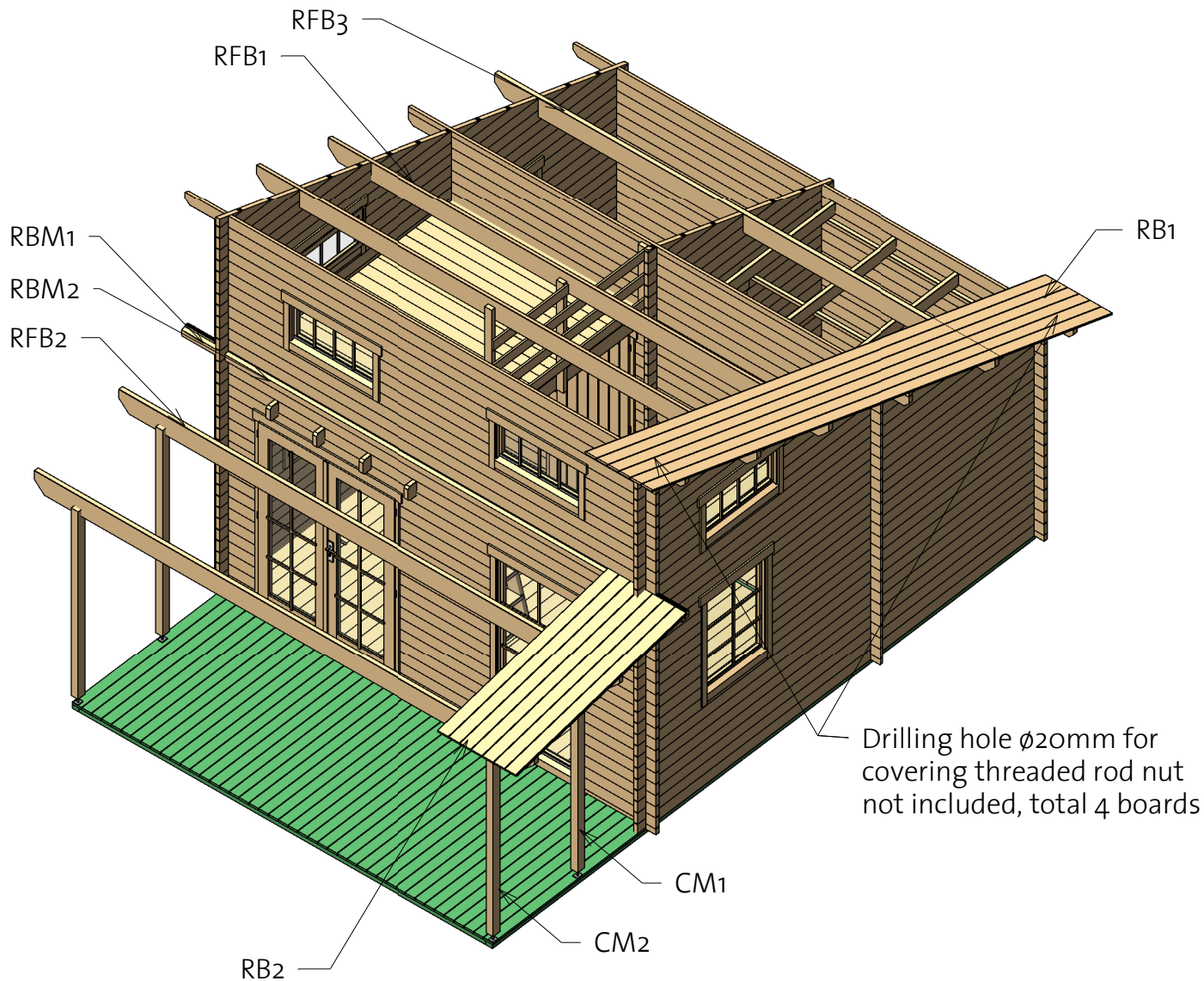
Roof 1

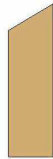

Roof				
Mark	Type	Profile	Count	Length

RB1	17x114		46	5673
RB2	17x114		46	2026
RBM1	Beam 40x70		2	400
RBM2	Beam 40x70		1	4220
RFB1	Beam 45x195		2	5100
RFB2	Beam 45x195		2	5100
RFB3	Beam 45x195		1	5100

Column schedule			
Mark	Type	Length	Count

CM1	Post 80x70	2094	2
CM2	Post 80x70	1920	2

# Sauna 40 (430x460)

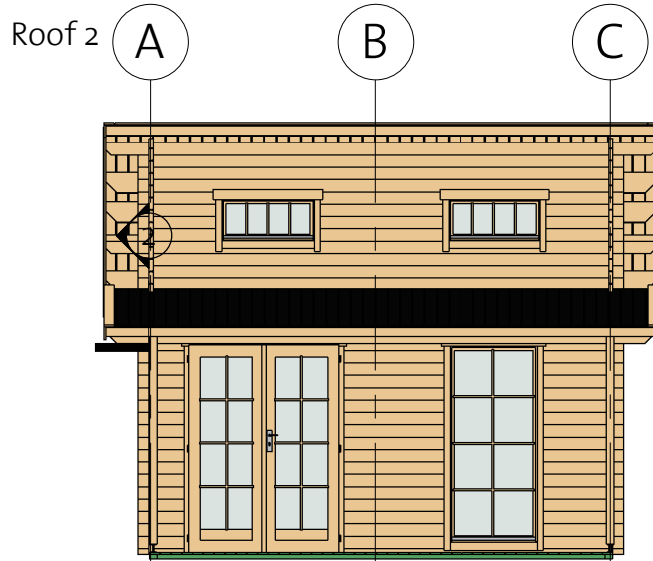



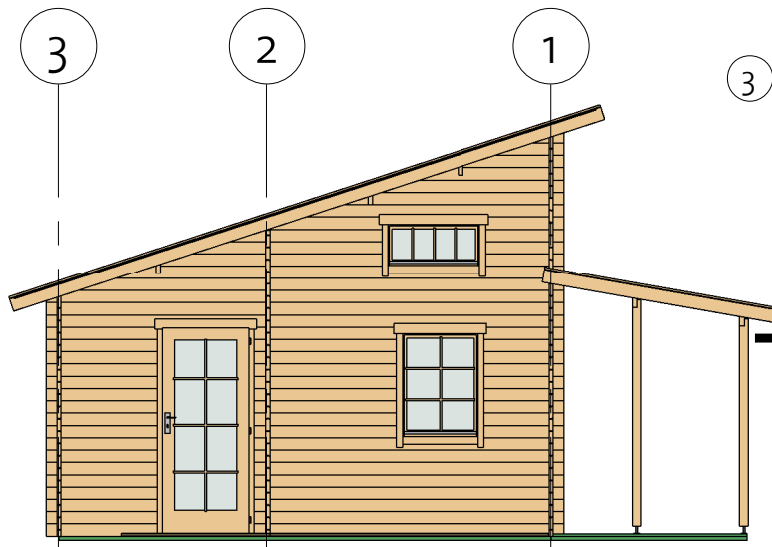
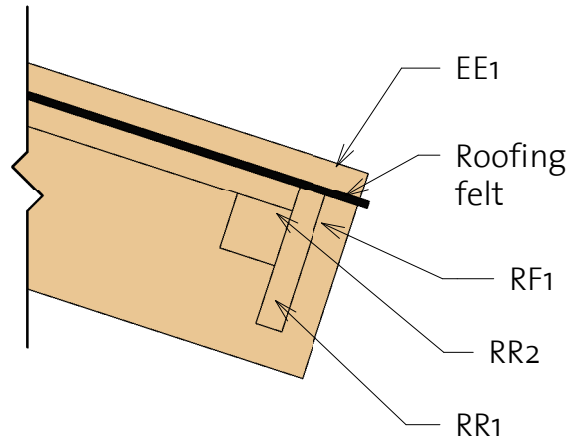

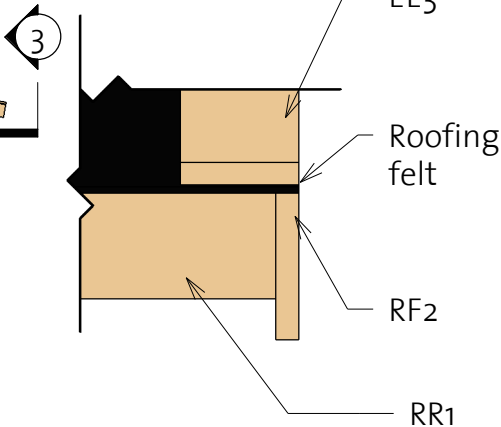

② Facia



③ Roof Reinforcement

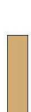

Fascia Schedule



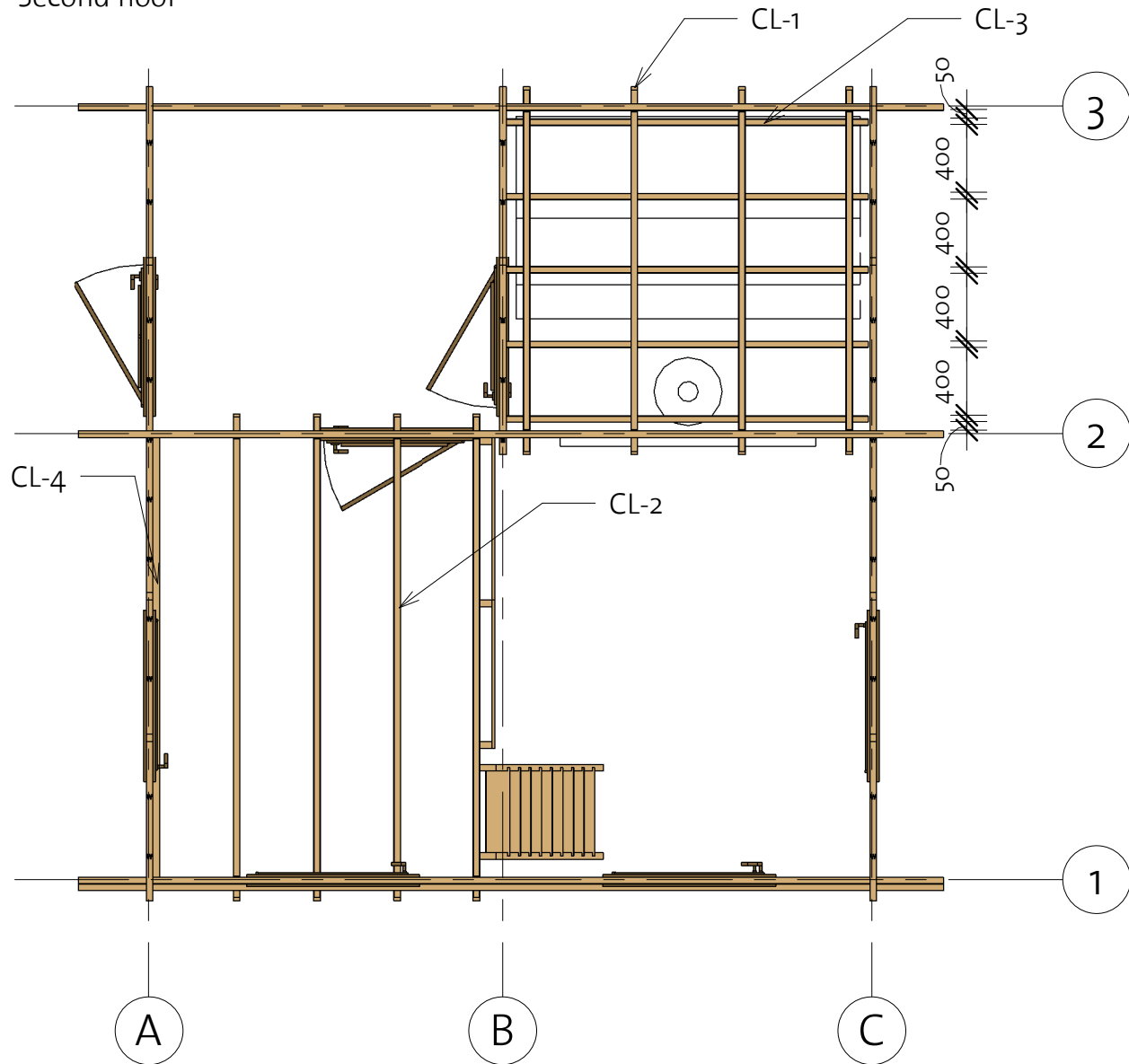

Mark	Type	Image	Count	Length
EE1	Eave Edging 18x95		2	5759
EE2	Eave Edging 18x95		1	4932
EE3	Eave Edging 18x95		2	2178
RF1	Roof Fascia 18x120		2	5759
RF2	Roof Fascia 18x120		2	2178
RR1	Roof reinforcement 18x95		3	5100
RR2	Roof reinforcement 38x38		3	5100

# Sauna 40 (430x460)

Second floor







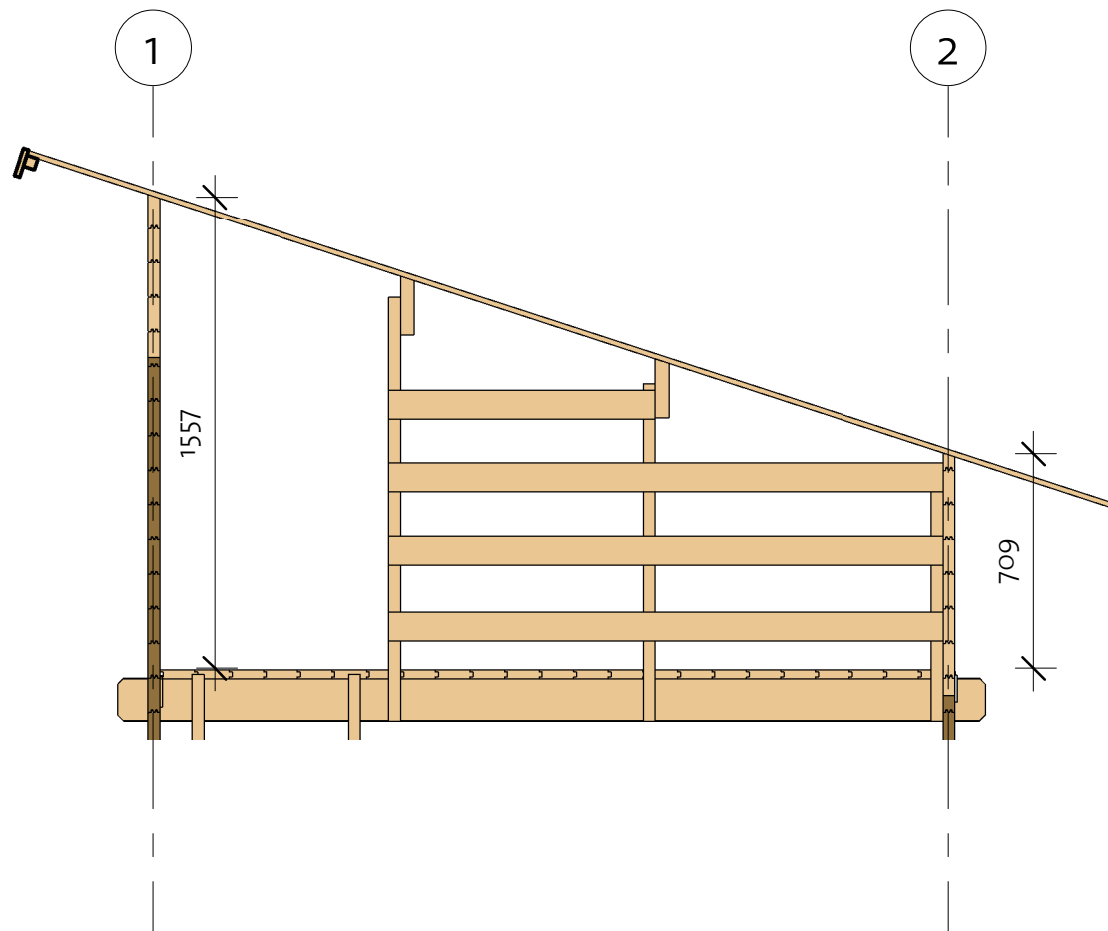

Second floor schedule

Mark	Type	Profile	Count	Length
CL-1	Ceiling beam 40x120		4	2170
CL-2	Ceiling beam 40x143		4	2870
CL-3	Batten 38x38		5	2125
CL-4	Log 40x114		1	2590

# Sauna 40 (430x460)

Fence





Fence schedule				
Mark	Type	Profile	Count	Length
FN1	Fence 40x70		1	1397
FN2	Fence 40x70		1	1112
FN3	Fence 40x70		1	850
FN4	Fence 18x95		1	880
FN5	Fence 18x95		3	1833

# Sauna 40 (430x460)

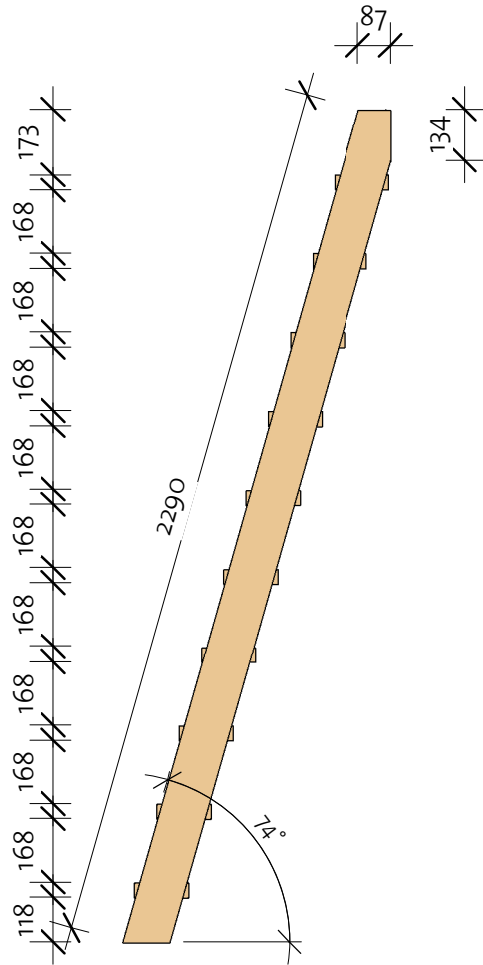
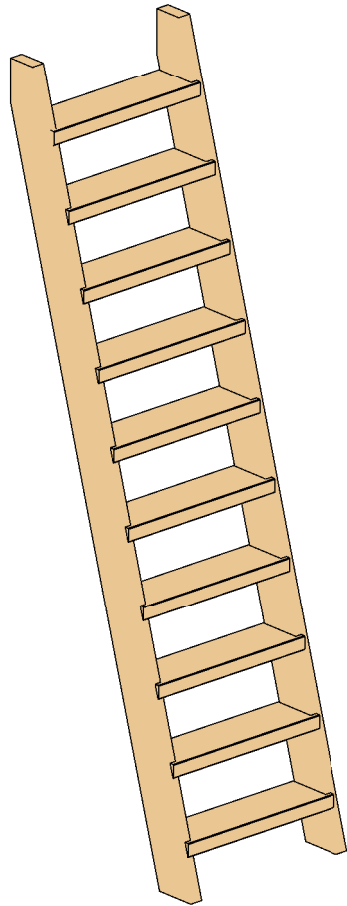
Stairs



Stairs				
Mark	Profile	Profile	Count	Cut Length
ST1L	Stair 40X120		1	2313
ST1R	Stair 40X120		1	2313
ST2	Stair 40X143		10	520

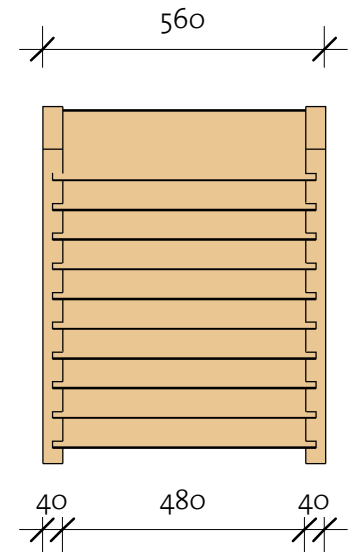



# Sauna 40 (430x460)

Extras 1



## Fasteners/Extras

Name	Type	Count
Hitblock	300-400 mm	
Threaded rod $\varnothing$ 8mm	2390mm	2
Threaded rod $\varnothing$ 8mm	3915 mm	2
Adjustable post foot		4
Nut, washer	$\varnothing$ 8mm	8
Nails	1,4 x 40	100
Screws	6,0 x 140	120
Screws	5,0 x 70	135
Screws	4,0 x 40	1650

## Door Schedule

Model	Type	Width	Height	Count
CDD3R	Classic double door 3 right	1425	1955	1
CD7R	Classic door 7, wood right	840	1955	1
CD6R	Classic door 6 right	840	1955	1
CD5L	Classic door 5, wood left	840	1890	1
DCB8	Door Crossbar 8 optional	--	--	3
DB	Door beam 850 mm	40	12	2

# Sauna 40 (430x460)

Extras 2

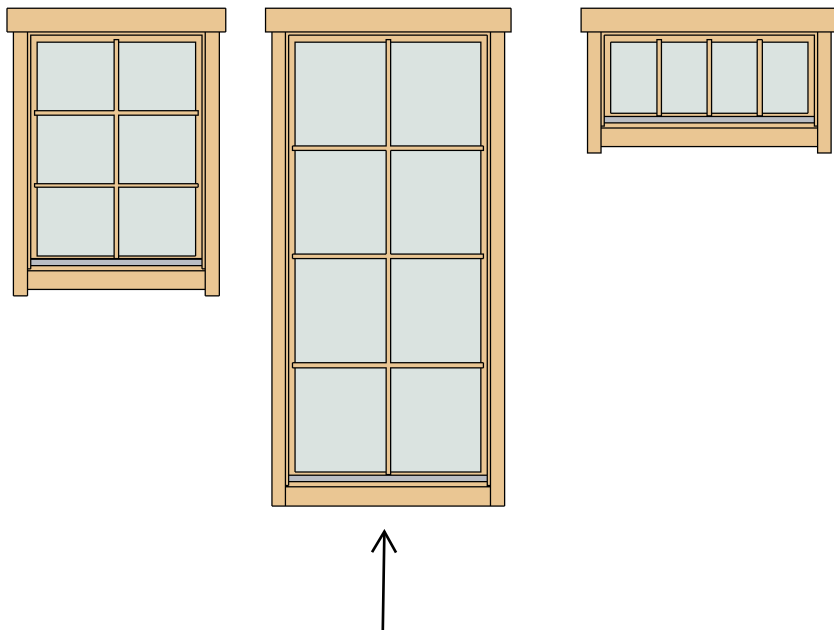

- \* Windows intended for tilt opening only!
- \* Fenster zur Eröffnung nur zum Kippen vorgesehen!
- \* Aknad on ette nähtud ainult kaldu avamiseks!

Window Schedule				
Mark	Type	Width	Height	Count
CW1L	Classic window 1 left	765	990	1
CW1R	Classic window 1 right	765	990	1
CW4R	Classic window 4 right	875	1890	1
CW5R	Classic window 5 right	915	420	4
WCB6-1	Windows Crossbar 6-1	--	--	2
WCB8	Windows Crossbar 8	--	--	1
WCB6-2	Windows Crossbar 6-2			4

# Sauna 40 (430x460)

## List of all items 1





### Impregnated foundation beams

Mark	Type	Profile	Count	Length
IFB1	IFB 70x40		2	4560
IFB2	IFB 70x40		2	1810
IFB3	IFB 70x40		16	4150
IFB4	IFB 70x40		8	395

### Floor Schedule

Mark	Type	Profile	Count	Length
FB1	FB 28x114		38	2584
FB2	FB 28x114		38	1882
FB3	FB 28x114		24	1929

### Fascia Schedule

Mark	Type	Image	Count	Length
EE1	Eave Edging 18x95		2	5759
EE2	Eave Edging 18x95		1	4932
EE3	Eave Edging 18x95		2	2178
RF1	Roof Fascia 18x120		2	5759
RF2	Roof Fascia 18x120		2	2178
RR1	Roof reinforcement 18x95		3	5100
RR2	Roof reinforcement 38x38		3	5100

### Column schedule

Mark	Type	Length	Count
CM1	Post 80x70	2094	2
CM2	Post 80x70	1920	2

### Sauna schedule

Type	Count
Sauna board pack	1
Sauna bench pack	1



### Terrace Schedule



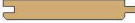

Mark	Type	Profile	Count	Length
TB	TB 21x95		45	1790

92203311\_220405

# Sauna 40 (430x460)

## List of all items 2

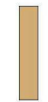

Roof				
Mark	Type	Profile	Count	Length
RB1	17x114		46	5673
RB2	17x114		46	2026
RBM1	Beam 40x70		2	400
RBM2	Beam 40x70		1	4220
RFB1	Beam 45x195		2	5100
RFB2	Beam 45x195		2	5100
RFB3	Beam 45x195		1	5100

Second floor schedule				
Mark	Type	Profile	Count	Length
CL-1	Ceiling beam 40x120		4	2170
CL-2	Ceiling beam 40x143		4	2870
CL-3	Batten 38x38		5	2125
CL-4	Log 40x114		1	2590

Fence schedule				
Mark	Type	Profile	Count	Length
FN1	Fence 40x70		1	1397
FN2	Fence 40x70		1	1112
FN3	Fence 40x70		1	850
FN4	Fence 18x95		1	880
FN5	Fence 18x95		3	1833

# Sauna 40 (430x460)

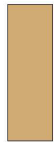
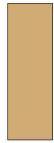
## List of all items 3

Stair				
Mark	Profile	Profile	Count	Cut Length
ST1L	Stair 40x120		1	2333
ST1R	Stair 40x120		1	2333
ST2	Stair 40x143		9	520

Wall 3			
Mark	Profile	Count	Cut Length

3BL-1	40x57	1	4500
3LG-1	40x114	18	4500
3LG-2	40x114	1	4500
3TL-1	40x114	1	5100

Wall 1			
Mark	Profile	Count	Cut Length
1BL-1	40x57	1	2617
1BL-2	40x57	1	443
1LG-1	40x114	17	443
1LG-2	40x114	17	765
1LG-3	40x114	17	967
1LG-4	40x114	9	4500
1LG-5	40x114	1	5100
1LG-6	40x114	8	740
1LG-7	40x114	4	1180
1LG-8	40x114	1	4500
1TL-1	40x114	1	5100

Wall 2			
Mark	Profile	Count	Cut Length

2BL-1	40x57	1	458
2BL-2	40x57	1	555
2BL-3	40x57	1	1138
2LG-1	40x114	12	458
2LG-2	40x114	12	555
2LG-3	40x114	17	1138
2LG-4	40x114	5	2512
2LG-5	40x114	6	4500
2LG-6	40x114	1	5100
2LG-7	40x114	1	4500
2TL-1	40x57	1	5100

# Sauna 40 (430x460)

## List of all items 4

Wall A			
Mark	Profile	Count	Cut Length

ALG-1 *	40X114	1	275
ALG-2 *	40X114	1	626
ALG-3 *	40X114	1	937
ALG-4 *	40X114	1	1328
ALG-5 *	40X114	1	1678
ALG-6 *	40X114	1	2029
ALG-7 *	40X114	1	2380
ALG-8 *	40X114	1	2730
ALG-9 *	40X114	4	750
ALG-10*	40X114	1	1412
ALG-11 *	40X114	1	1762
ALG-12*	40X114	1	2073
ALG-13*	40X114	1	2464
ALG-14*	40X114	1	4485
ALG-15*	40X114	1	4800
ALG-16	40X114	3	4800
ALG-17	40X114	9	1365
ALG-18	40X114	9	765
ALG-19	40X114	8	2900
ALG-20	40X114	17	1050

\* Gable - delivered premounted

Wall B			
Mark	Profile	Count	Cut Length

BLG-1 *	40X114	1	452
BLG-2 *	40X114	1	802
BLG-3 *	40X114	1	1113
BLG-4 *	40X114	1	1504
BLG-5 *	40X114	1	1855
BLG-6 *	40X114	1	2170
BLG-7	40X114	3	2170
BLG-8	40X114	17	1050
BLG-9	40X114	17	270
BLG-10*	40X114	1	100



Wall C			
Mark	Profile	Count	Cut Length

CLG-1 *	40X114	1	275
CLG-2 *	40X114	1	626
CLG-3 *	40X114	1	937
CLG-4 *	40X114	1	1328
CLG-5 *	40X114	1	1678
CLG-6 *	40X114	1	2029
CLG-7 *	40X114	1	2380
CLG-8 *	40X114	1	2730
CLG-9 *	40X114	4	750
CLG-10*	40X114	1	1412
CLG-11 *	40X114	1	1762
CLG-12*	40X114	1	2073
CLG-13*	40X114	1	2464
CLG-14*	40X114	1	4485
CLG-15*	40X114	1	4800
CLG-16	40X114	11	4800
CLG-17	40X114	9	3265
CLG-18	40X114	9	765

# Sauna 40 (430x460)

## List of all items 5

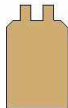
Log profiles	
Profile	Profile

40x57	
40x114	
40x114	
40x57	