

Aianurgasaun 40 (208x208)

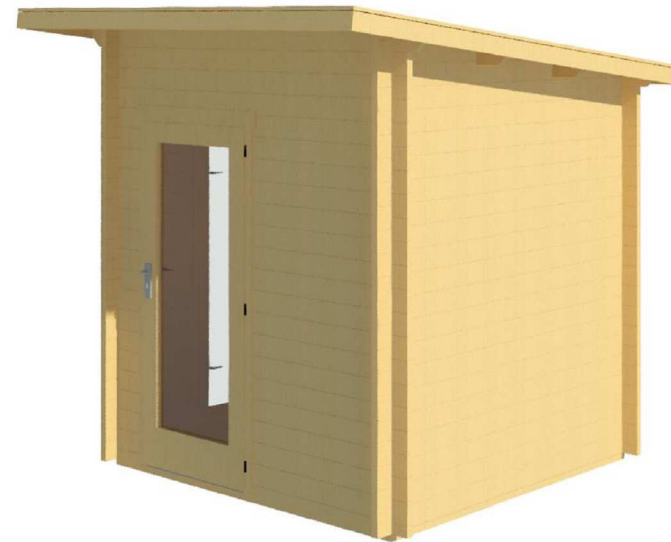

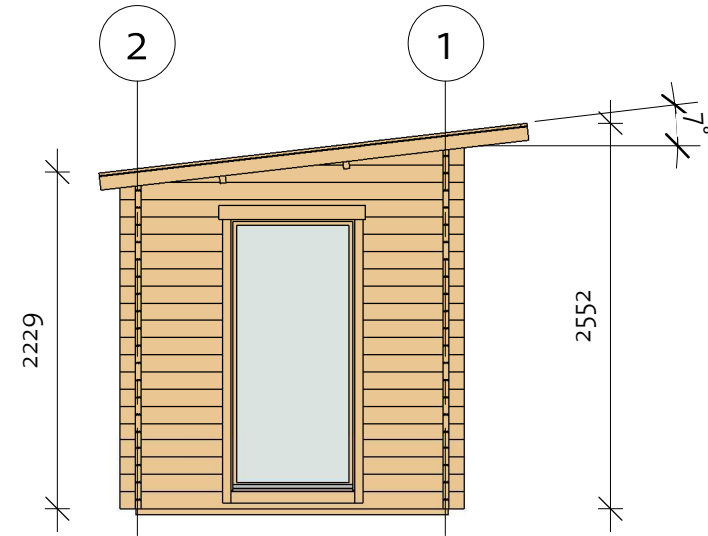

Aianurgasaun 40 (208x208)

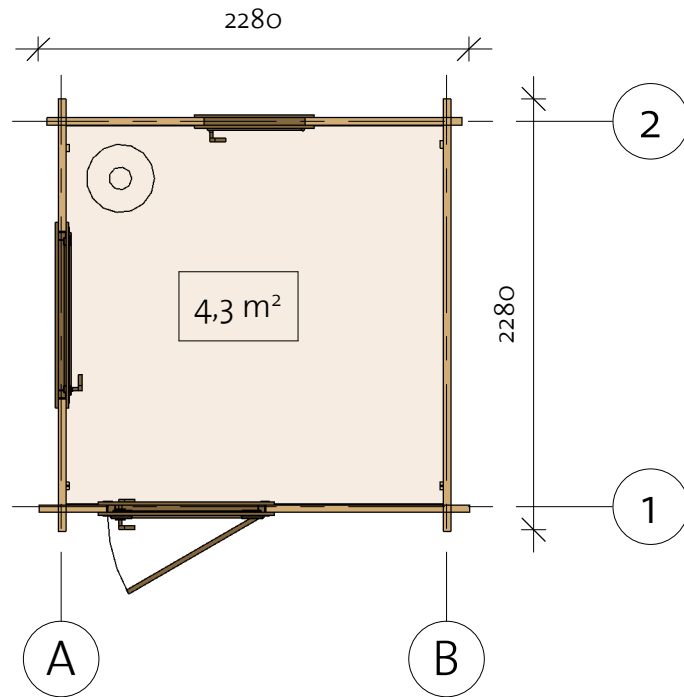
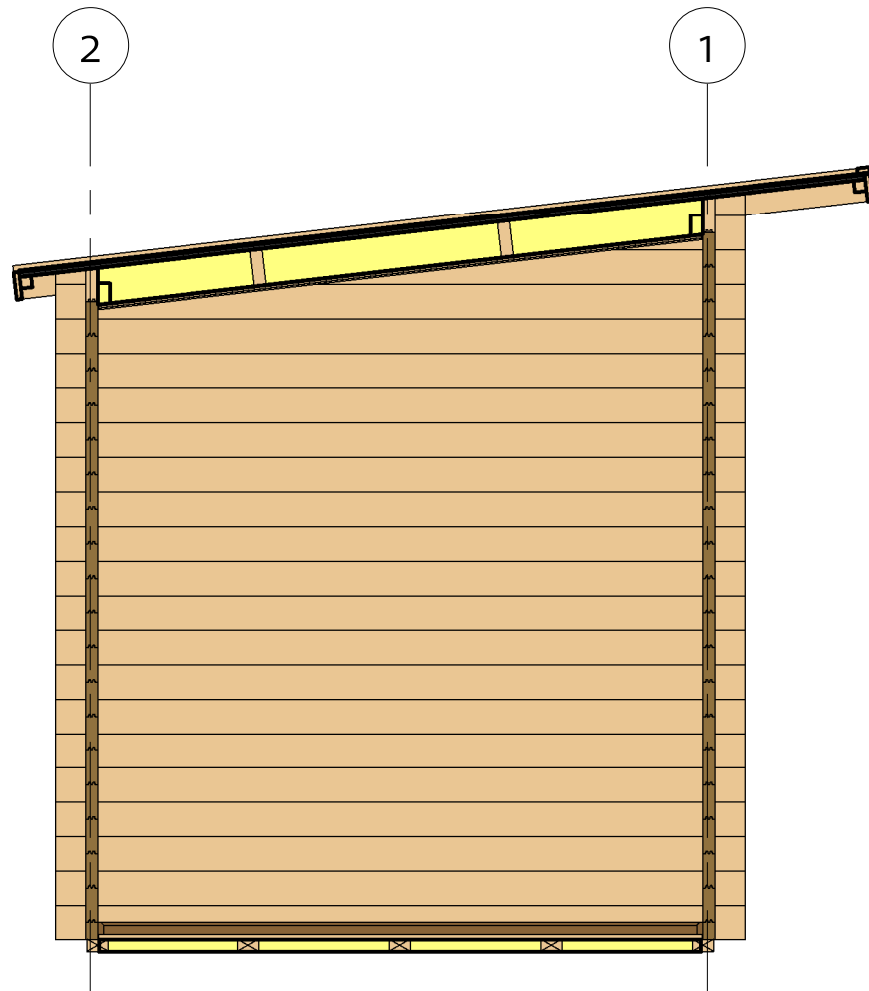

Aianurgasaun 40 (208x208)

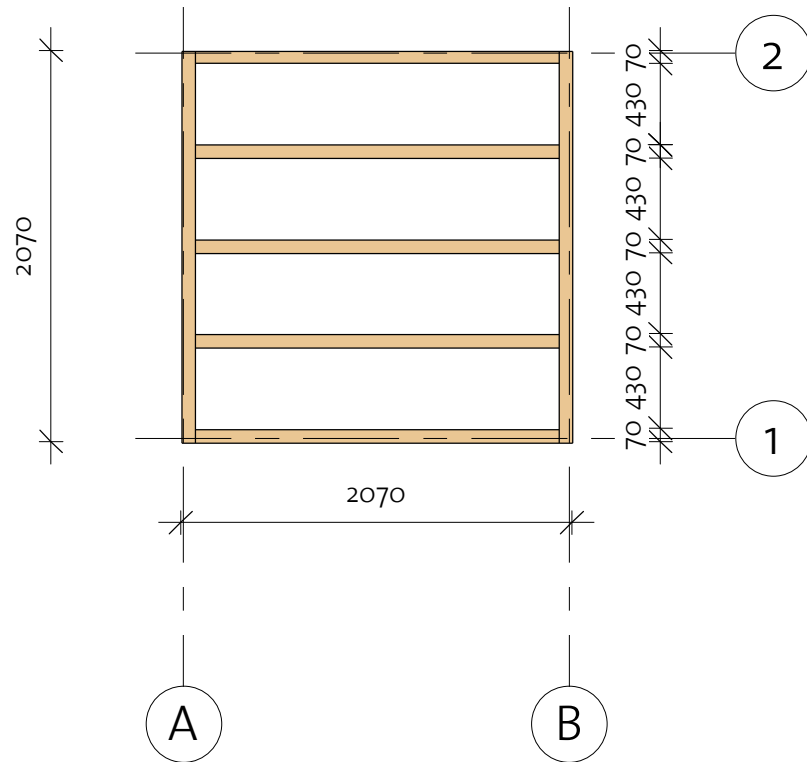
Foundation



Impregnated foundation beams				
Mark	Type	Profile	Count	Length
IFB1	IFB 70x40		2	2070
IFB2	IFB 70x40		5	1930



Aianurgasaun 40 (208x208)

Floor Plan

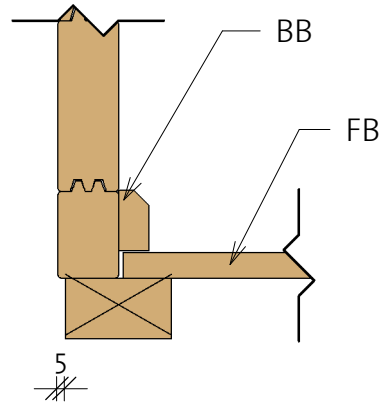
① Baseboard



Floor Schedule

Mark	Type	Profile	Count	Length
FB	FB 17x114		18	1994
BB	BB 20x40		4	2100

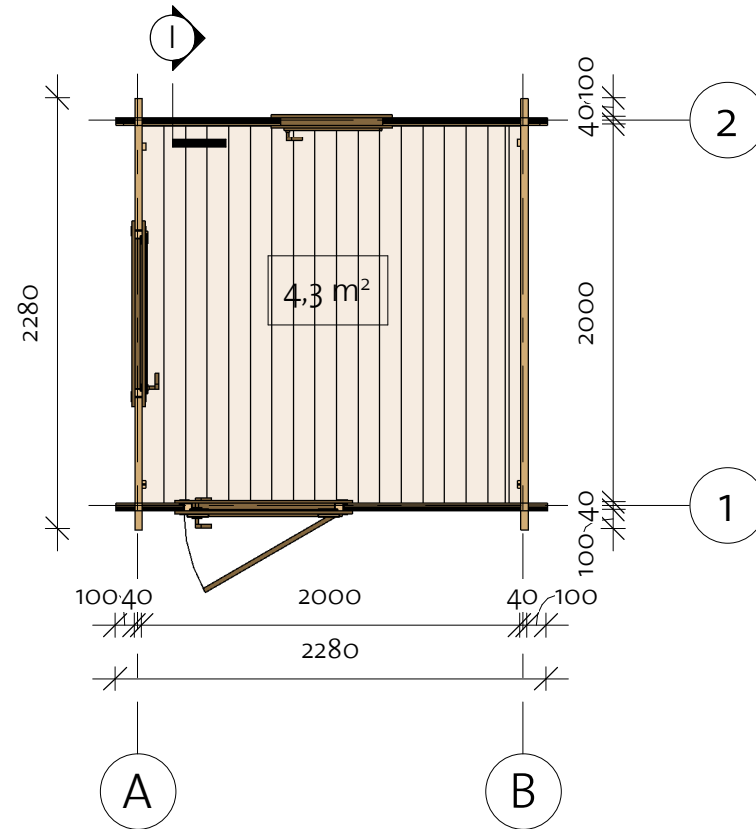

Aianurgasaun 40 (208x208)

Wall 1

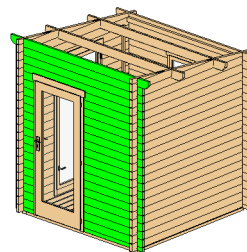

Wall 1			
Mark	Profile	Count	Cut Length

1BL-1	40X57	1	355
1BL-2	40X57	1	1075
1LG-2	40X114	17	1075
1LG-3	40X114	3	2280
1LG-4	40X114	17	355
1TL-1	40X114	1	2480

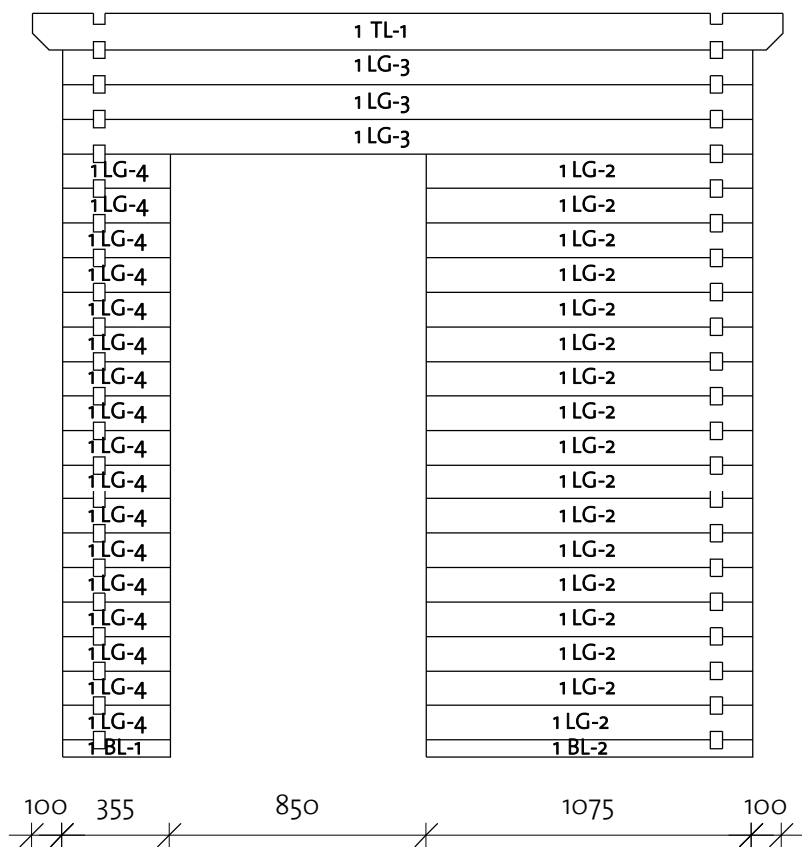

Log Profile Wall 1	
Profile	Profile

40X57	
<varies>	
40X114	

Aianurgasaun 40 (208x208)

Wall 2

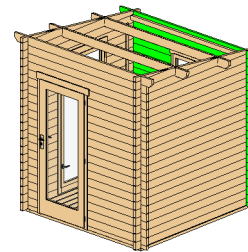

Wall 2			
Mark	Profile	Count	Cut Length

2BL-1	40x57	1	2280
2LG-1	40x114	13	2280
2LG-2	40x114	10	865
2TL-1	40x114	1	2480

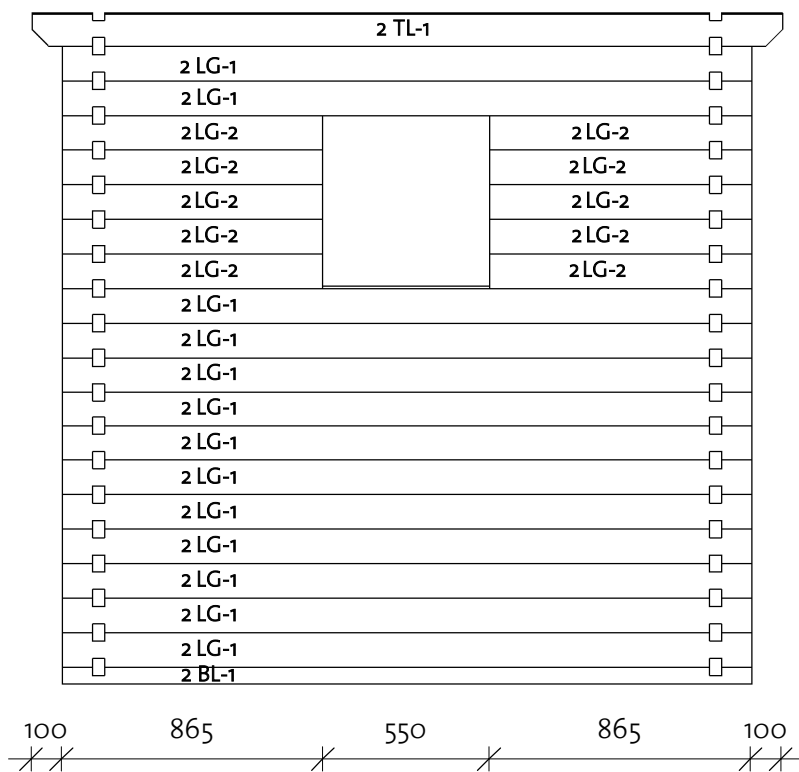

Log Profile Wall 2	
Profile	Profile

40x57	
40x114	
40x114	

Aianurgasaun 40 (208x208)

Wall A

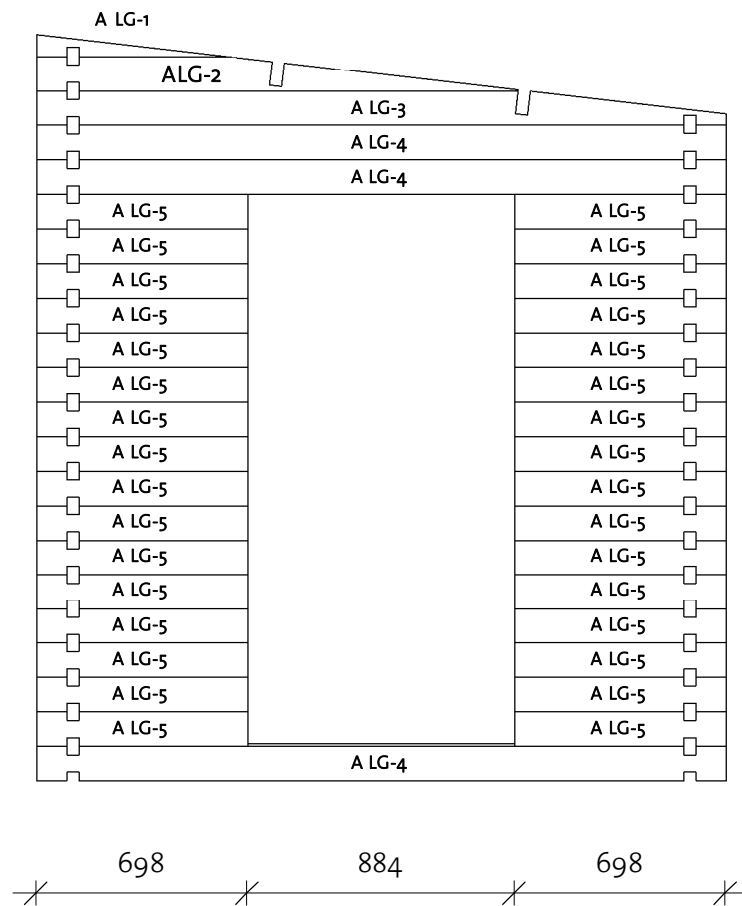
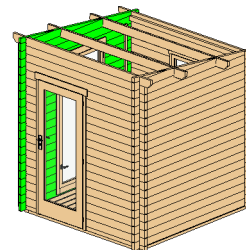

Wall A			
Mark	Profile	Count	Cut Length

ALG-1*	40x114	1	642
ALG-2*	40x114	1	1594
ALG-3*	40x114	1	2280
ALG-4	40x114	3	2280
ALG-5	40x114	32	698

* Gable - delivered premounted

Log Profile Wall A	
Profile	Profile

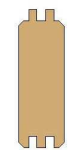
40x114	
--------	---

Aianurgasaun 40 (208x208)

Wall B

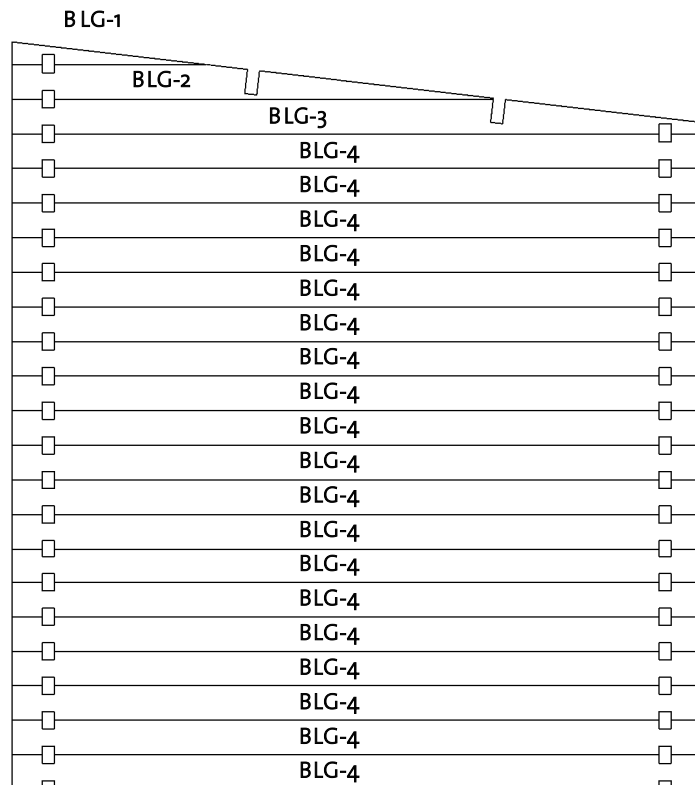
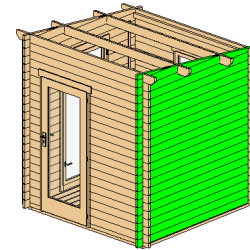

Wall B			
Mark	Profile	Count	Cut Length

BLG-1*	40x114	1	642
BLG-2*	40x114	1	1594
BLG-3*	40x114	1	2280
BLG-4	40x114	19	2280

* Gable - delivered premounted





Log Profile Wall B	
Profile	Profile

40x114	
--------	--

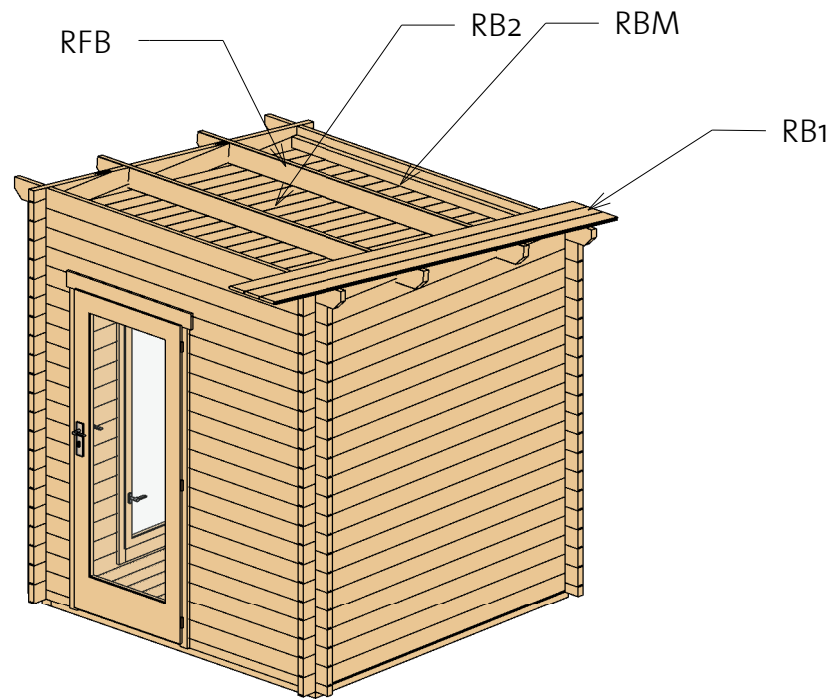
Aianurgasaun 40 (208x208)

Roof 1



Roof				
Mark	Type	Profile	Count	Length
RB1	17x114		22	2817
RB2	17x114		18	2010
RBM	40x70		2	2000
RFB	Beam 40x120		2	2480

Aianurgasaun 40 (208x208)

Roof 2

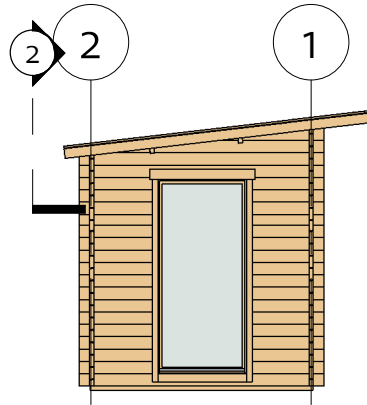

② Facia

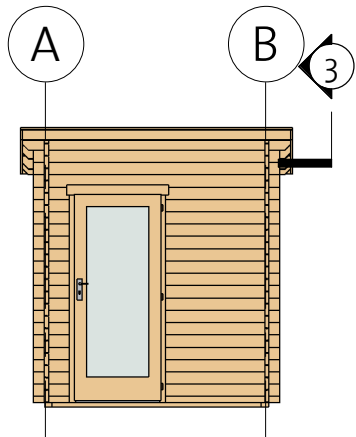
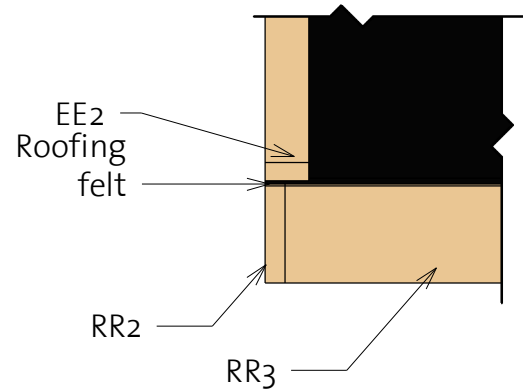

③ Roof Reinforcement

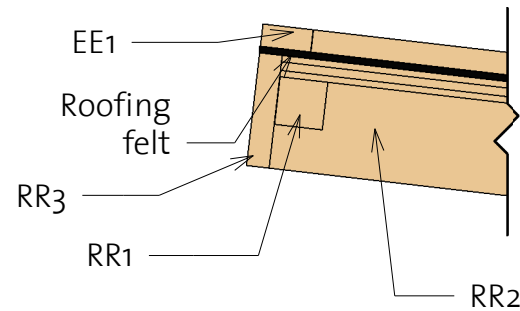

Fascia Schedule				
Mark	Type	Profile	Count	Length
EE1	Eave Edging 18x40		1	2516
EE2	Eave Edging 18x40		2	2813
RR1	Roof reinforcement 38x38		2	2480
RR2	Roof reinforcement 18x95		2	2853
RR3	Roof reinforcement 18x95		2	2480

Aianurgasaun 40 (208x208)

Extras

- * Windows intended for tilt opening only!
- * Fenster zur Eröffnung nur zum Kippen vorgesehen!
- * Aknad on ette nähtud ainult kaldu avamiseks!

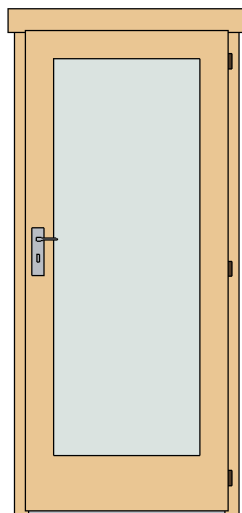

Door Schedule				
Mark	Type	Width	Height	Count

CD6R	Classic door 6 right	840	1955	1
------	-------------------------	-----	------	---

DCB8	Door Crossbar 8	--	--	1
------	--------------------	----	----	---

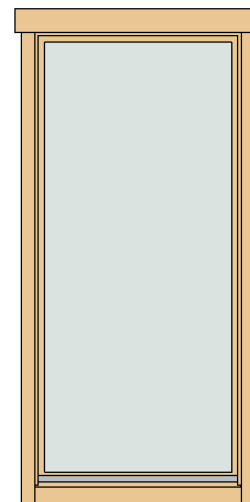

Window Schedule				
Mark	Type	Width	Height	Count

CW4R	Classic window 4, right	875	1890	1
------	-------------------------------	-----	------	---

CW12R	Classic window 12, full glass right	540	540	1
-------	--	-----	-----	---

WCB8	Windows Crossbar 8	--	--	1
------	-----------------------	----	----	---

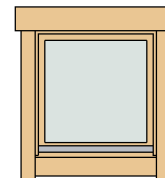

Fasteners/Extras		
Name	Type	Count

Hitblock	300-400 mm	
Screws	5,0 x 70	10
Bolts	M8 x 70	12
Nails	1,4 x 40	25
Screws	6,0 x 140	35
Screws	4,0 x 40	600



Type	Count	Length
------	-------	--------



Windboard1 18x40	2	2200
Windboard2 18x40	2	2000











Aianurgasaun 40 (208x208)

List of all items 1

Impregnated foundation beams				
Mark	Type	Profile	Count	Length
IFB1	IFB 70x40		2	2070
IFB2	IFB 70x40		5	1930

Floor Schedule				
Mark	Type	Profile	Count	Length
FB	FB 17x114		18	1994
BB	BB 20x40		4	2100

Roof					Fascia Schedule				
Mark	Type	Profile	Count	Length	Mark	Type	Profile	Count	Length
RB1	17x114		22	2817	EE1	Eave Edging 18x40		1	2516
RB2	17x114		18	2010	EE2	Eave Edging 18x40		2	2813
RBM	40x70		2	2000	RR1	Roof reinforcement 38x38		2	2480
RFB	Beam 40x120		2	2480	RR2	Roof reinforcement 18x95		2	2853
					RR3	Roof reinforcement 18x95		2	2480

Aianurgasaun 40 (208x208)

List of all items 2

Wall 1

Mark	Profile	Count	Cut Length
------	---------	-------	------------

1BL-1	40x57	1	355
1BL-2	40x57	1	1075
1LG-2	40x114	17	1075
1LG-3	40x114	3	2280
1LG-4	40x114	17	355
1TL-1	40x114	1	2480



Wall A

Mark	Profile	Count	Cut Length
------	---------	-------	------------

ALG-1*	40x114	1	642
ALG-2*	40x114	1	1594
ALG-3*	40x114	1	2280
ALG-4	40x114	3	2280
ALG-5	40x114	32	698

Log Profiles

Profile	Profile
---------	---------

40x57	
40x114	

Wall 2

Mark	Profile	Count	Cut Length
------	---------	-------	------------

2BL-1	40x57	1	2280
2LG-1	40x114	13	2280
2LG-2	40x114	10	865
2TL-1	40x114	1	2480

Wall B

Mark	Profile	Count	Cut Length
------	---------	-------	------------

BLG-1*	40x114	1	642
BLG-2*	40x114	1	1594
BLG-3*	40x114	1	2280
BLG-4	40x114	19	2280

* Gable - delivered premounted

Log Profiles

Profile	Profile
---------	---------

40x114	
--------	---