

# Svea I 40 (450x550)

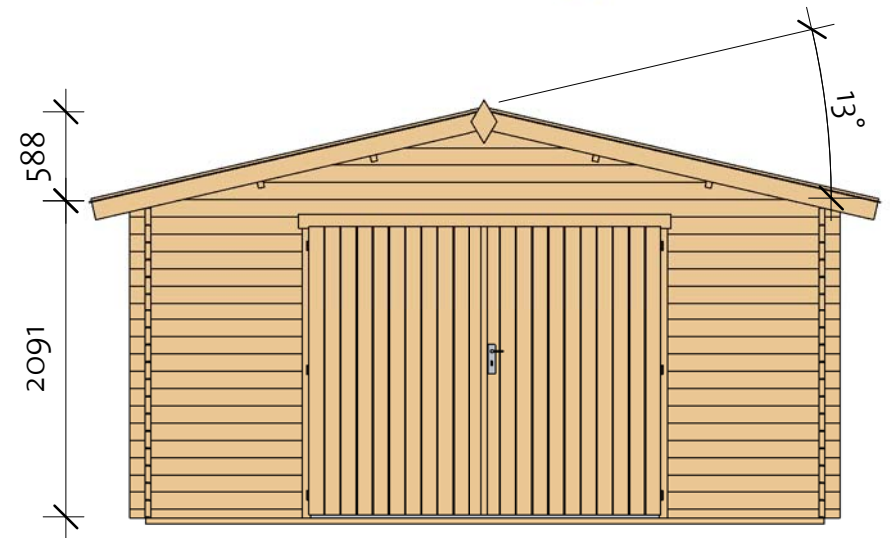

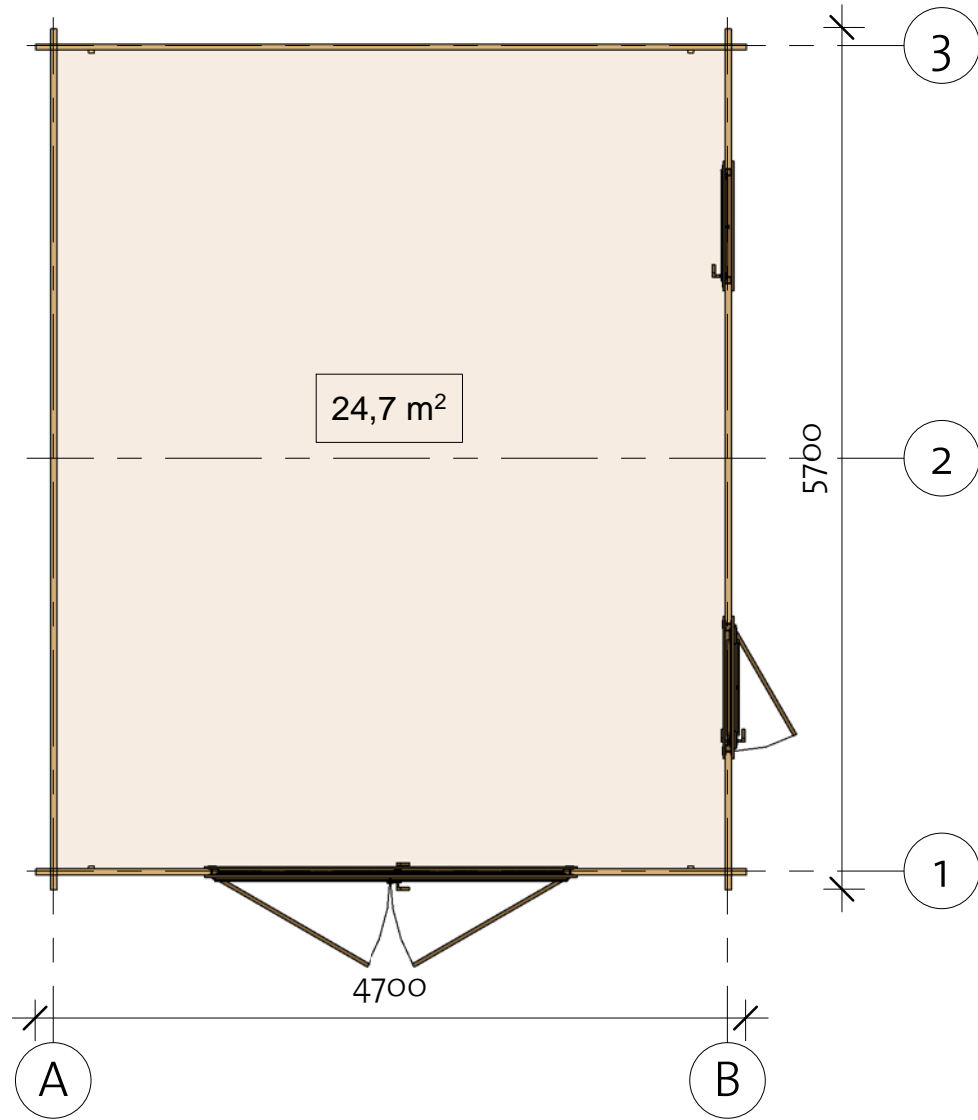
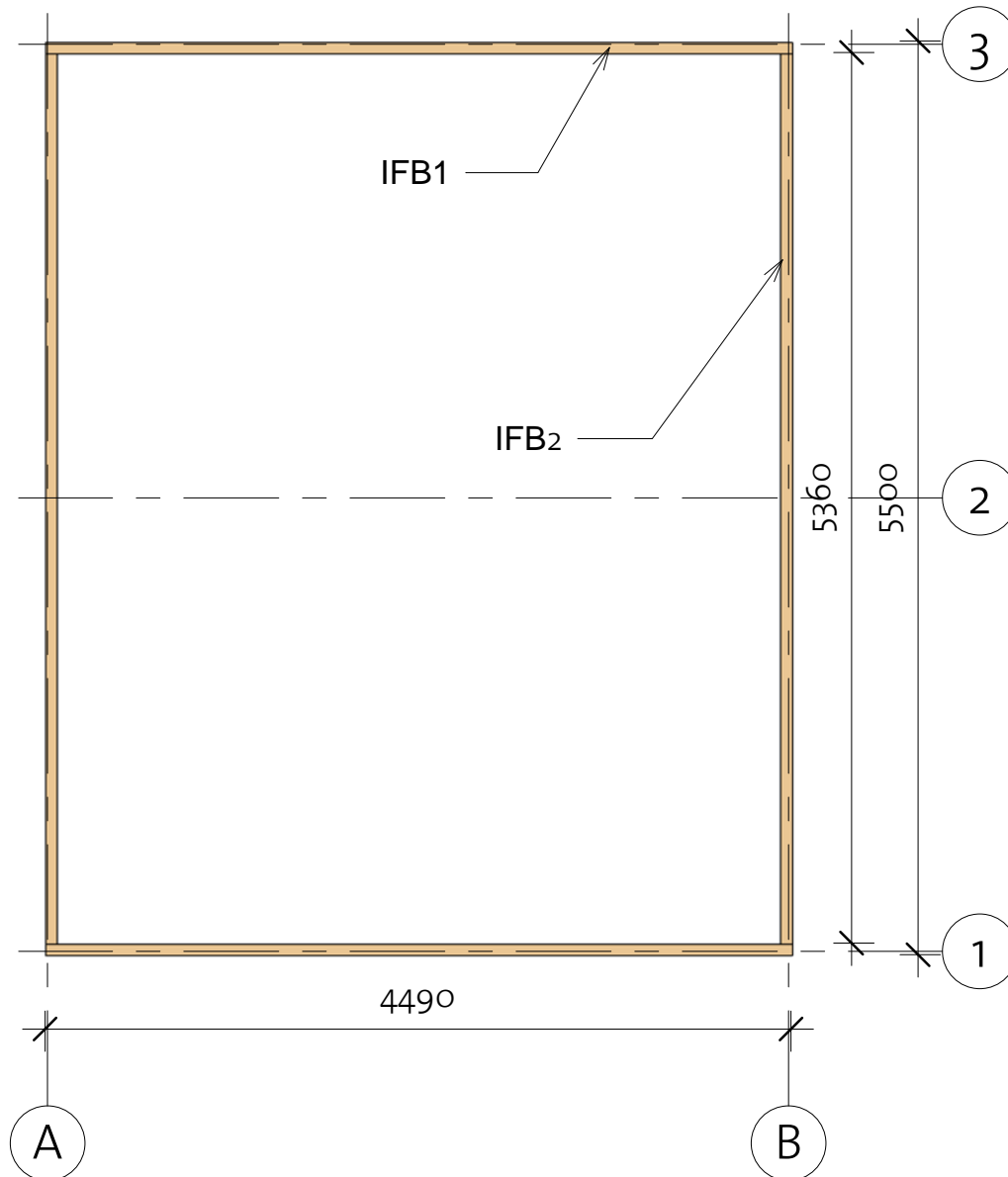

# Svea I 40 (450x550)

Foundation



Impregnated foundation beams				
Mark	Type	Profile	Count	Length

IFB1	IFB 70x40		2	4490
IFB2	IFB 70x40		2	5360

# Svea I 40 (450x550)

Floor Plan

① Foundation

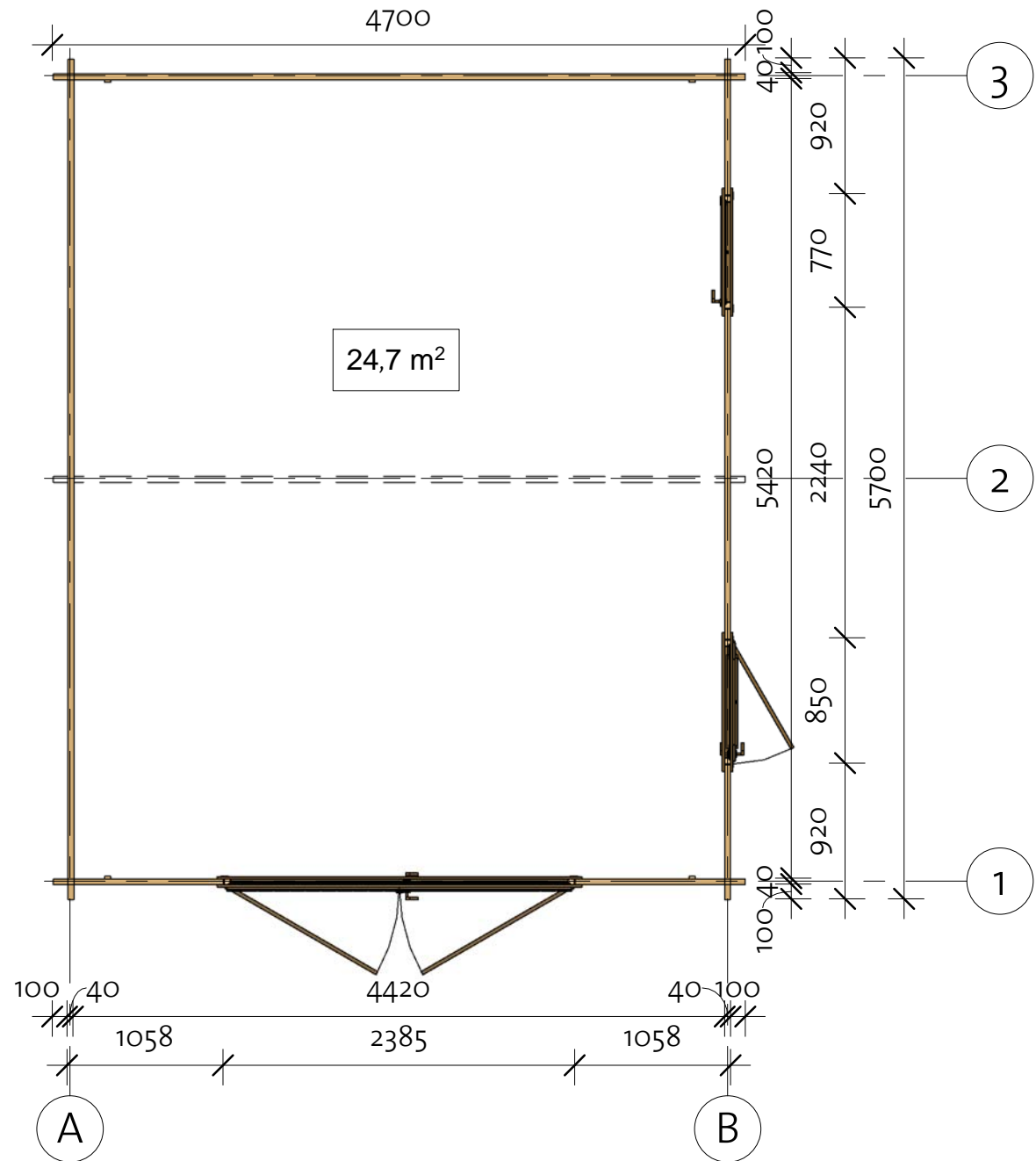
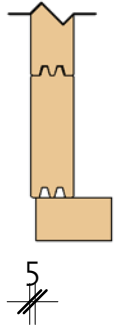

# Svea I 40 (450x550)

Wall 1

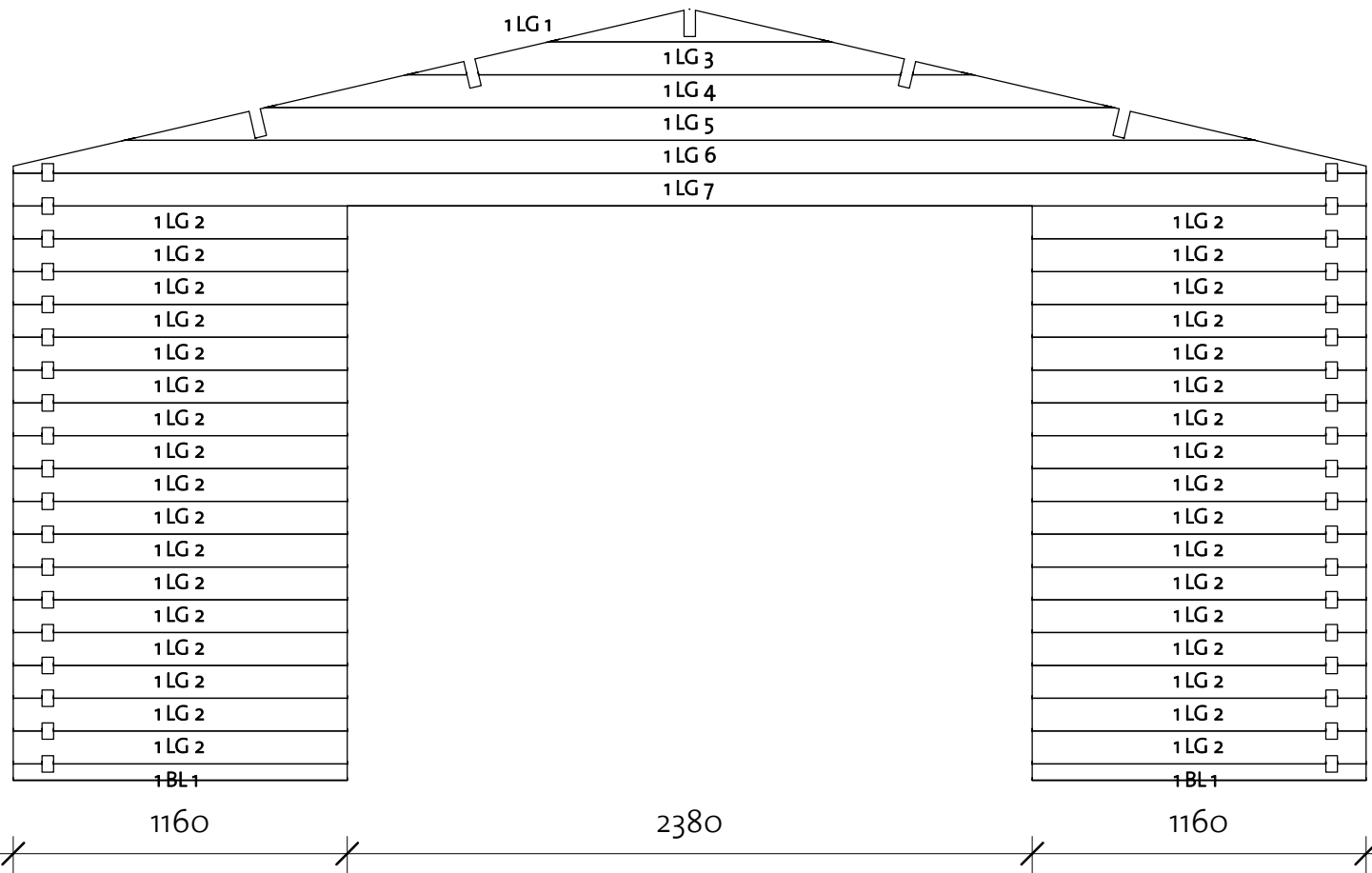
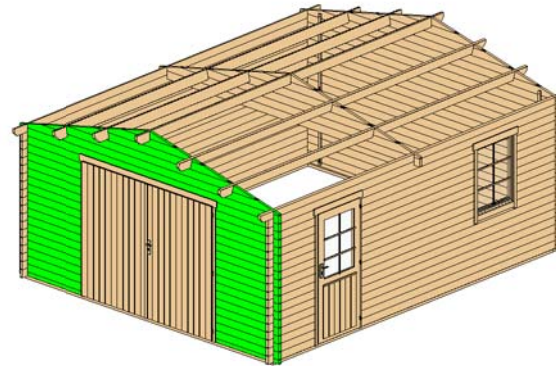

4400003\_190918

Wall 1			
Mark	Profile	Count	Cut Length

1BL 1	40x57	2	1160
1LG 1*	40x114	1	983
1LG 2	40x114	34	1160
1LG 3*	40x114	1	1965
1LG 4*	40x114	1	2947
1LG 5*	40x114	1	3929
1LG 6*	40x114	1	4700
1LG 7	40x114	1	4700

\* Gable - delivered premounted

Log Profile Wall 1	
Profile	Profile

40x57	
40x114	

# Svea I 40 (450x550)

Wall 2

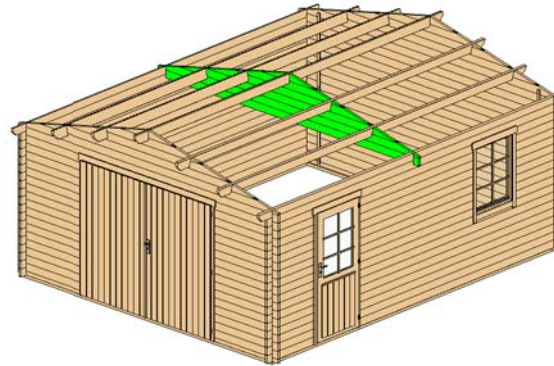

Wall 2			
Mark	Profile	Count	Cut Length

2LG 1*	40x114	1	983
2LG 2*	40x114	1	1965
2LG 3*	40x114	1	2947
2LG 4*	40x114	1	3929
2LG 5*	40x114	1	4700
2LG 6	40x114	1	4700

\* Gable - delivered premounted

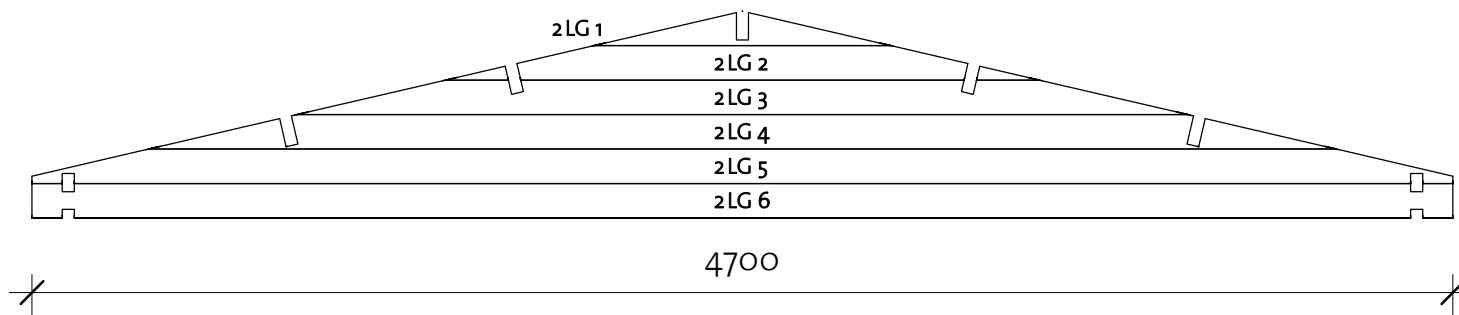

Log Profile Wall 2	
Profile	Profile

40x114	
--------	--

# Svea I 40 (450x550)

Wall 3

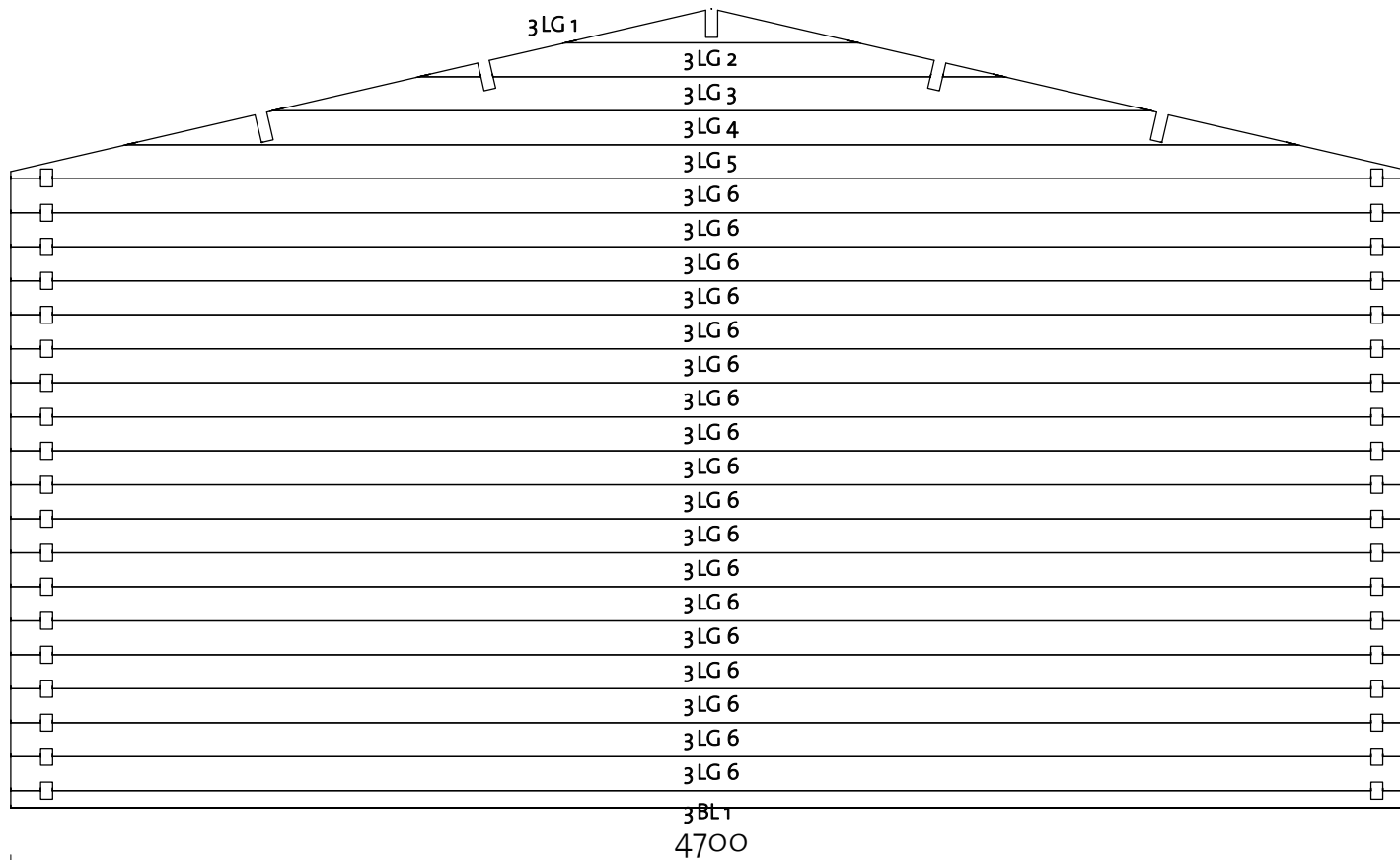
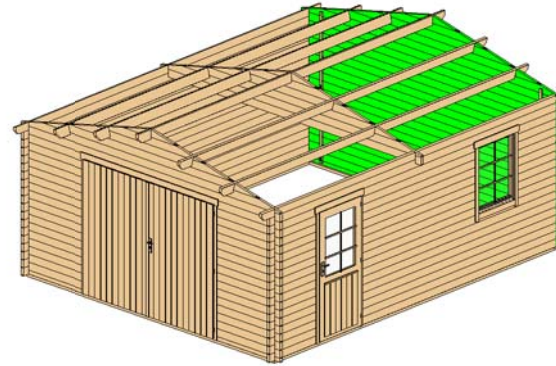

Wall 3			
Mark	Profile	Count	Cut Length

3BL 1	40x57	1	4700
3LG 1 *	40x114	1	983
3LG 2 *	40x114	1	1965
3LG 3 *	40x114	1	2947
3LG 4 *	40x114	1	3929
3LG 5 *	40x114	1	4700
3LG 6	40x114	18	4700

\* Gable - delivered premounted

Log Profile Wall 3	
Profile	Profile

40x57	
40x114	

# Svea I 40 (450x550)

Wall A

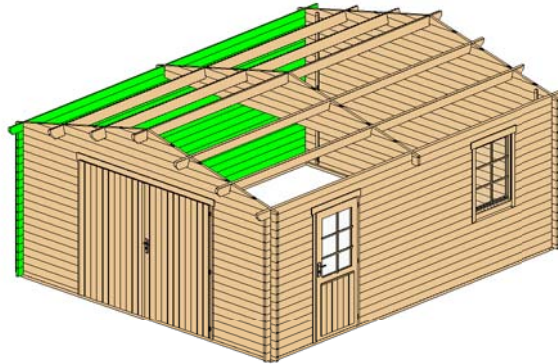

Wall A			
Mark	Profile	Count	Cut Length

ALG 1	40x114	17	5700
ALG 2	40x114	1	5700
ATL 1	40x114	1	5950

Log Profile Wall A	
Profile	Profile

40x114	
40x114	

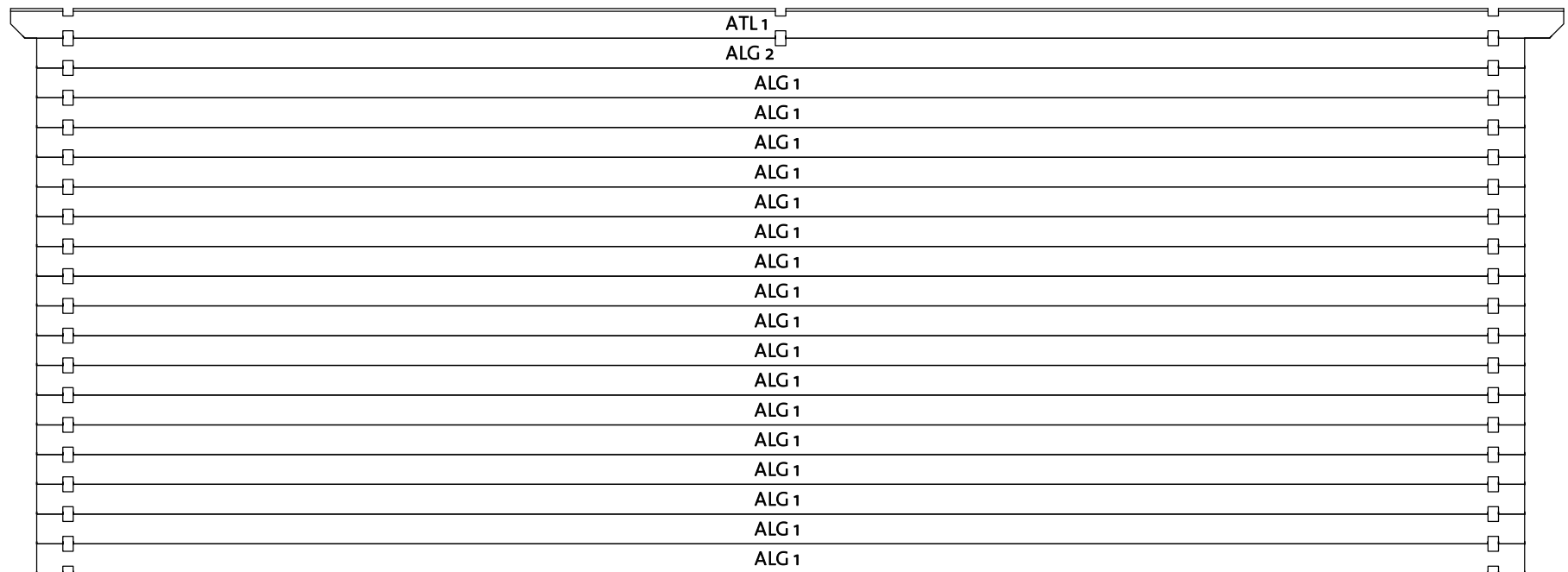

100  
//

5700

150  
//

4400003\_190918

# Svea I 40 (450x550)

Wall B

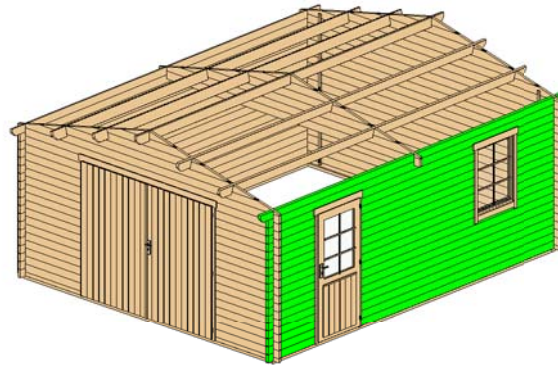

Wall B			
Mark	Profile	Count	Cut Length

BLG 1	40X114	8	3930
BLG 2	40X114	26	920
BLG 3	40X114	9	2240
BLG 4	40X114	1	5700
BTL 1	40X114	1	5950

Log Profile Wall B	
Profile	Profile

40X114	
40X114	

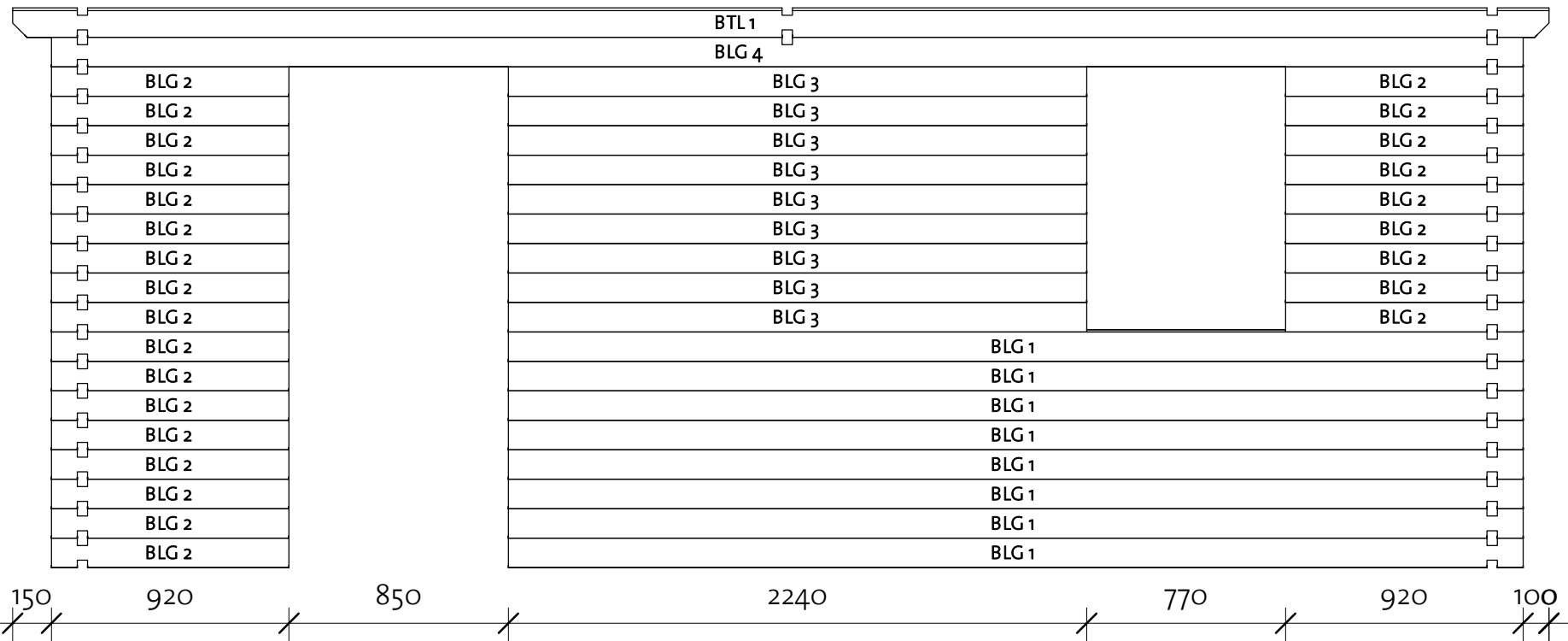





4400003\_190918

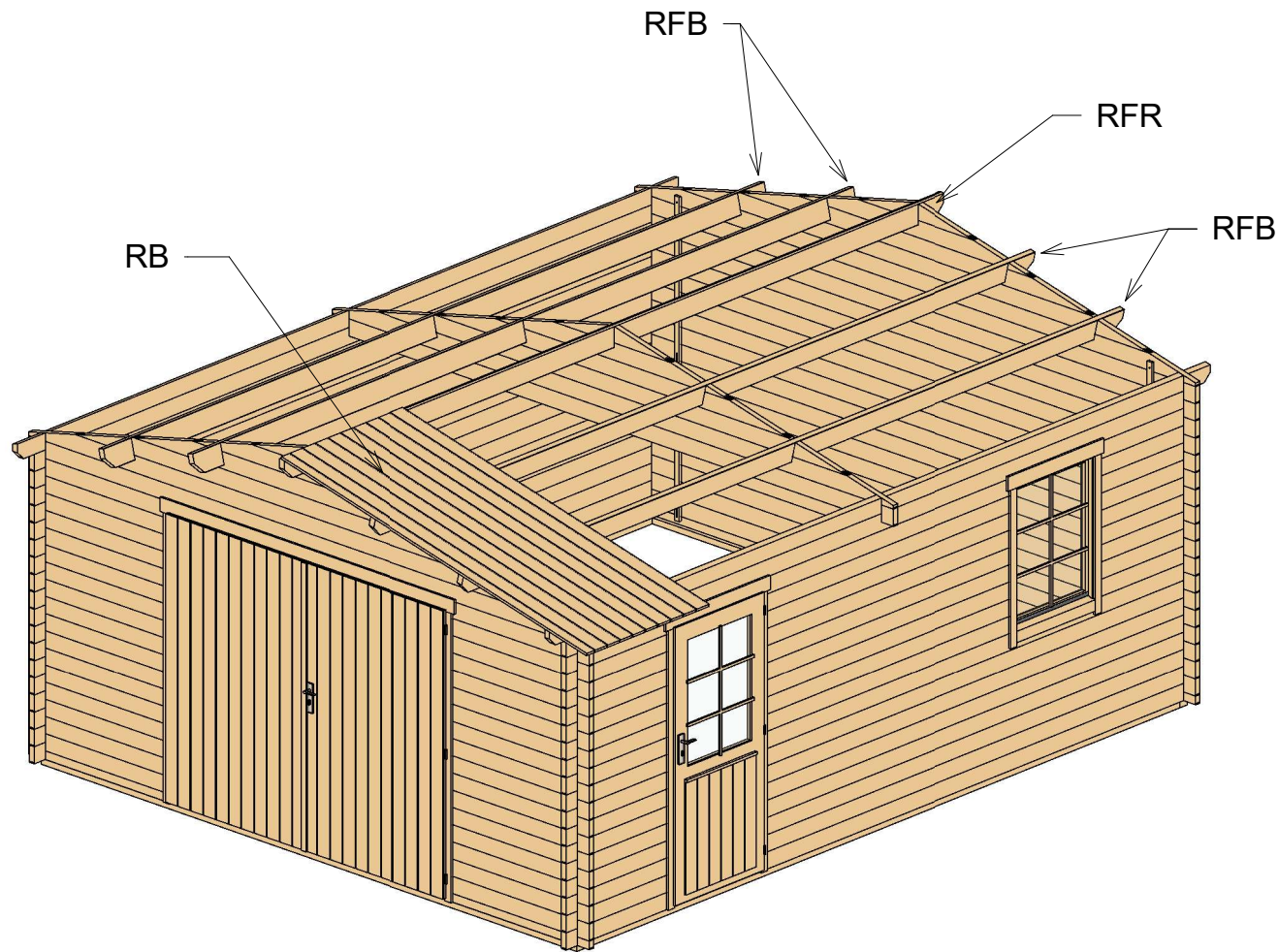

# Svea I 40 (450x550)

Roof 1



Roof				
Mark	Type	Profile	Count	Length
RFR	Ridge 40x143		1	5950
RFB	Beam 40x143		4	5950
RB	17x114		108	2632

# Svea I 40 (450x550)

Roof 2

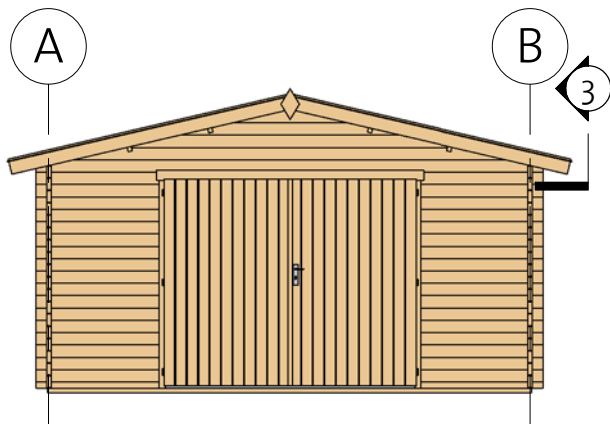
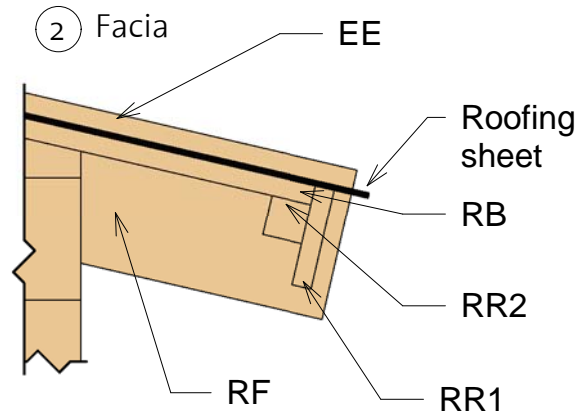
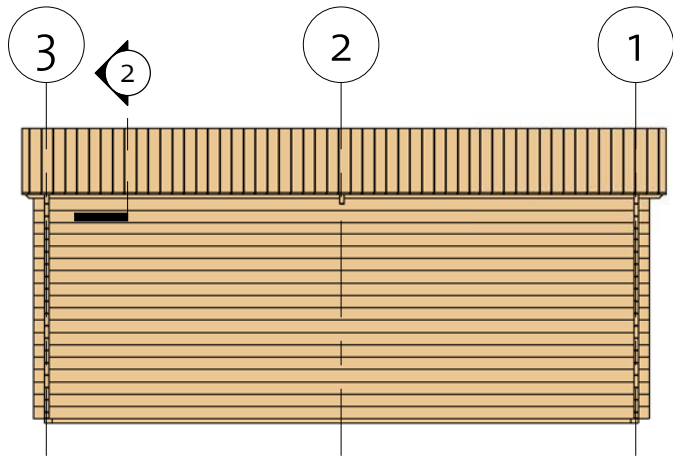

3 Roof Reinforcement

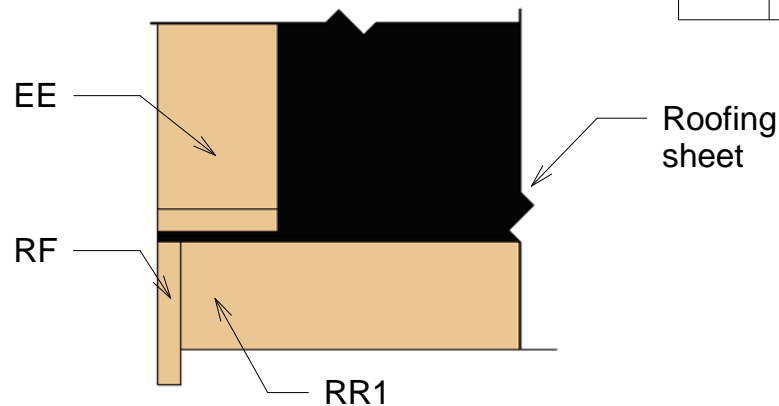

Fascia Schedule				
Mark	Type	Profile	Count	Length
EE	Eave Edging 18x95		4	2670
RF	Roof Fascia 18x120		4	2670
RR1	Roof reinforcement 18x95		2	5950
RR2	Roof reinforcement 38x38		2	5950

# Svea I 40 (450x550)

Extras

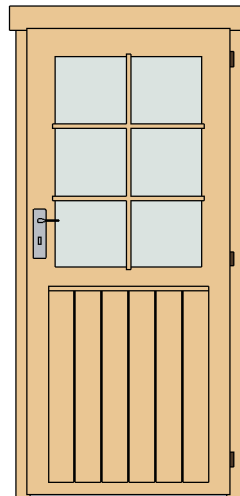
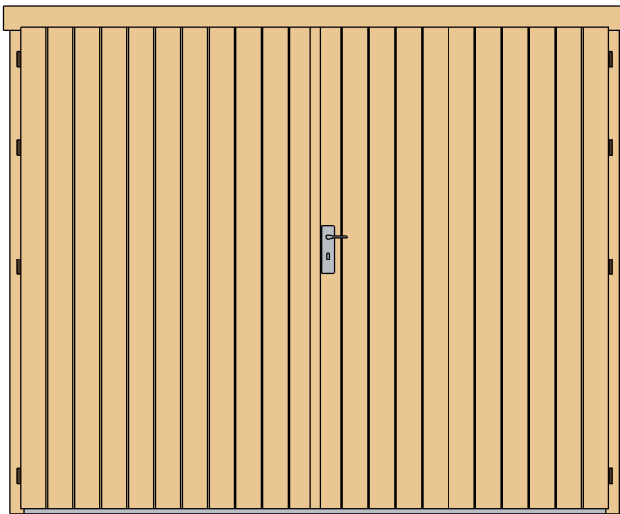

Door Schedule				
Mark	Type	Width	Height	Count
CD1R	Classic door 1 right	840	1890	1
CDD10R	Classic double door 10, wood right	2370	1955	1
DCB6	Door Crossbar 6	--	--	1

Fasteners/Extras		
Name	Type	Count

Hitblock	300-400 mm	
Door bolt	315 x 65	2
Bolts	M8 x 70	12
Screws	5,0 x 70	15
Screws	5,0 x 40	16
Screws	6,0 x 140	60
Screws	4,0 x 40	90
Screws	4,0 x 50	500

Type	Count	Length
------	-------	--------

Windboard 18x40	4	2200
--------------------	---	------

Family	Count
--------	-------

Romb	2
------	---

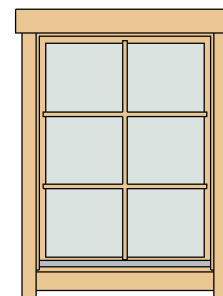



Window Schedule				
Mark	Type	Width	Height	Count
CW1L	Classic window 1 left	765	990	1
WCB6	Window Crossbar 6	--	--	1

4400003\_201008



# Svea I 40 (450x550)

## List of all items 1





Impregnated foundation beams				
Mark	Type	Profile	Count	Length

IFB1	IFB 70x40		2	4490
IFB2	IFB 70x40		2	5360

Roof				
Mark	Type	Profile	Count	Length

RFR	Ridge 40x143		1	5950
RFB	Beam 40x143		4	5950
RB	17x114		108	2632

Fascia Schedule				
Mark	Type	Profile	Count	Length

EE	Eave Edging 18x95		4	2670
RF	Roof Fascia 18x120		4	2670
RR1	Roof reinforcement 18x95		2	5950
RR2	Roof reinforcement 38x38		2	5950

# Svea I 40 (450x550)

## List of all items 2

Wall 1			
Mark	Profile	Count	Cut Length



1BL 1	40x57	2	1160
1LG 1 *	40x114	1	983
1LG 2	40x114	34	1160
1LG 3 *	40x114	1	1965
1LG 4 *	40x114	1	2947
1LG 5 *	40x114	1	3929
1LG 6 *	40x114	1	4700
1LG 7	40x114	1	4700

Wall 3			
Mark	Profile	Count	Cut Length

3BL 1	40x57	1	4700
3LG 1 *	40x114	1	983
3LG 2 *	40x114	1	1965
3LG 3 *	40x114	1	2947
3LG 4 *	40x114	1	3929
3LG 5 *	40x114	1	4700
3LG 6	40x114	18	4700

\*Gable-delivered premounted

Log Profiles	
Profile	Profile

40x57	
40x114	

Wall 2			
Mark	Profile	Count	Cut Length

2LG 1 *	40x114	1	983
2LG 2 *	40x114	1	1965
2LG 3 *	40x114	1	2947
2LG 4 *	40x114	1	3929
2LG 5 *	40x114	1	4700
2LG 6	40x114	1	4700

Wall A			
Mark	Profile	Count	Cut Length

ALG 1	40x114	17	5700
ALG 2	40x114	1	5700
ATL 1	40x114	1	5950

Wall B			
Mark	Profile	Count	Cut Length

BLG 1	40x114	8	3930
BLG 2	40x114	26	920
BLG 3	40x114	9	2240
BLG 4	40x114	1	5700
BTL 1	40x114	1	5950

Log Profiles	
Profile	Profile

40x114	
--------	---