

# Nora I 40 (300x550)

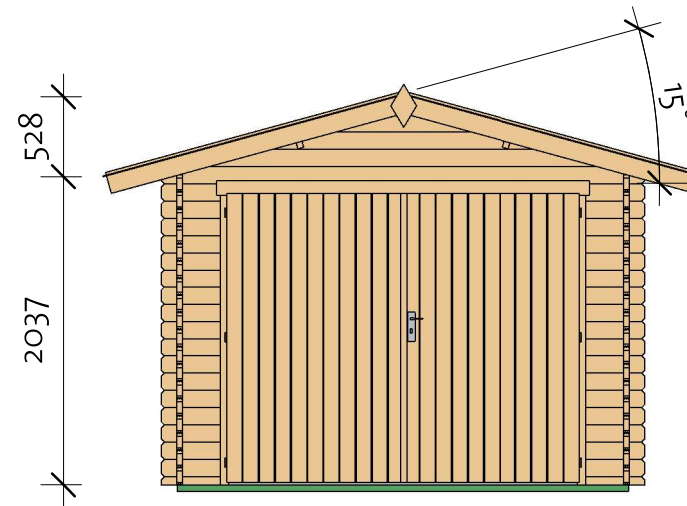

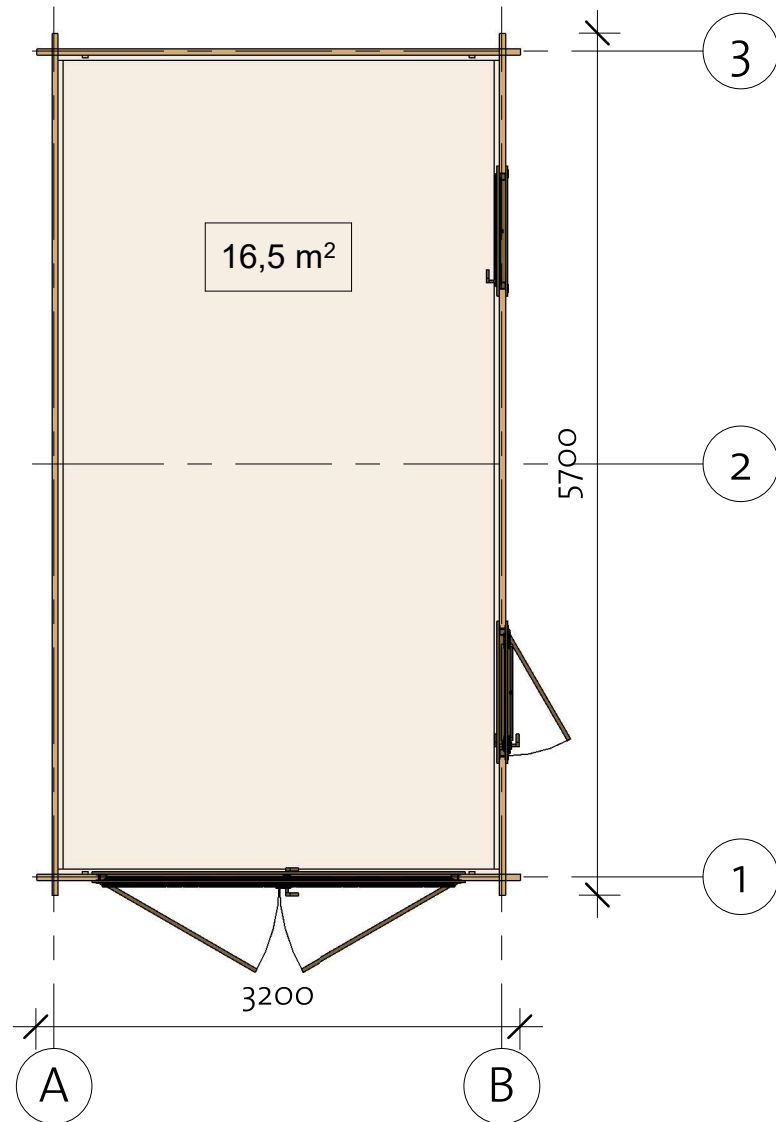
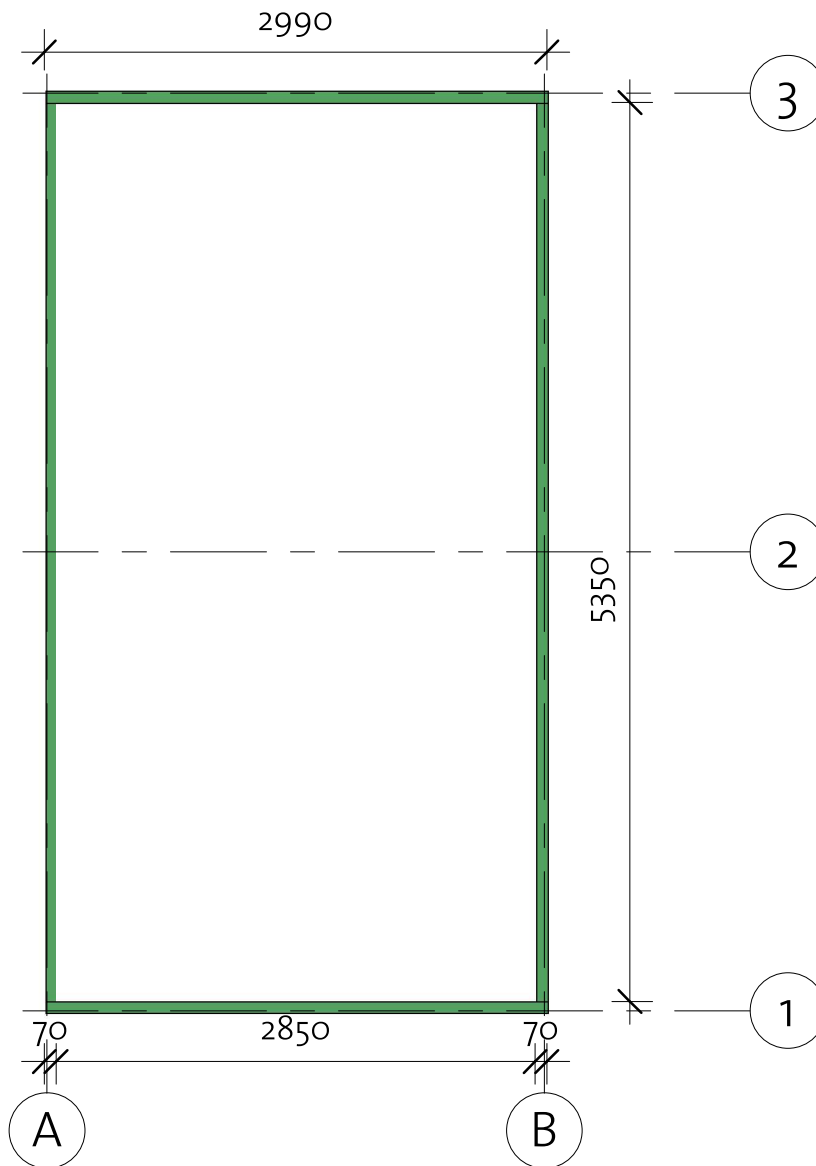

# Nora I 40 (300x550)

Foundation



Impregnated foundation beams				
Mark	Type	Profile	Count	Length

IFB1	IFB 70x40		2	2990
IFB2	IFB 70x40		2	5350

# Nora I 40 (300x550)

Floor Plan

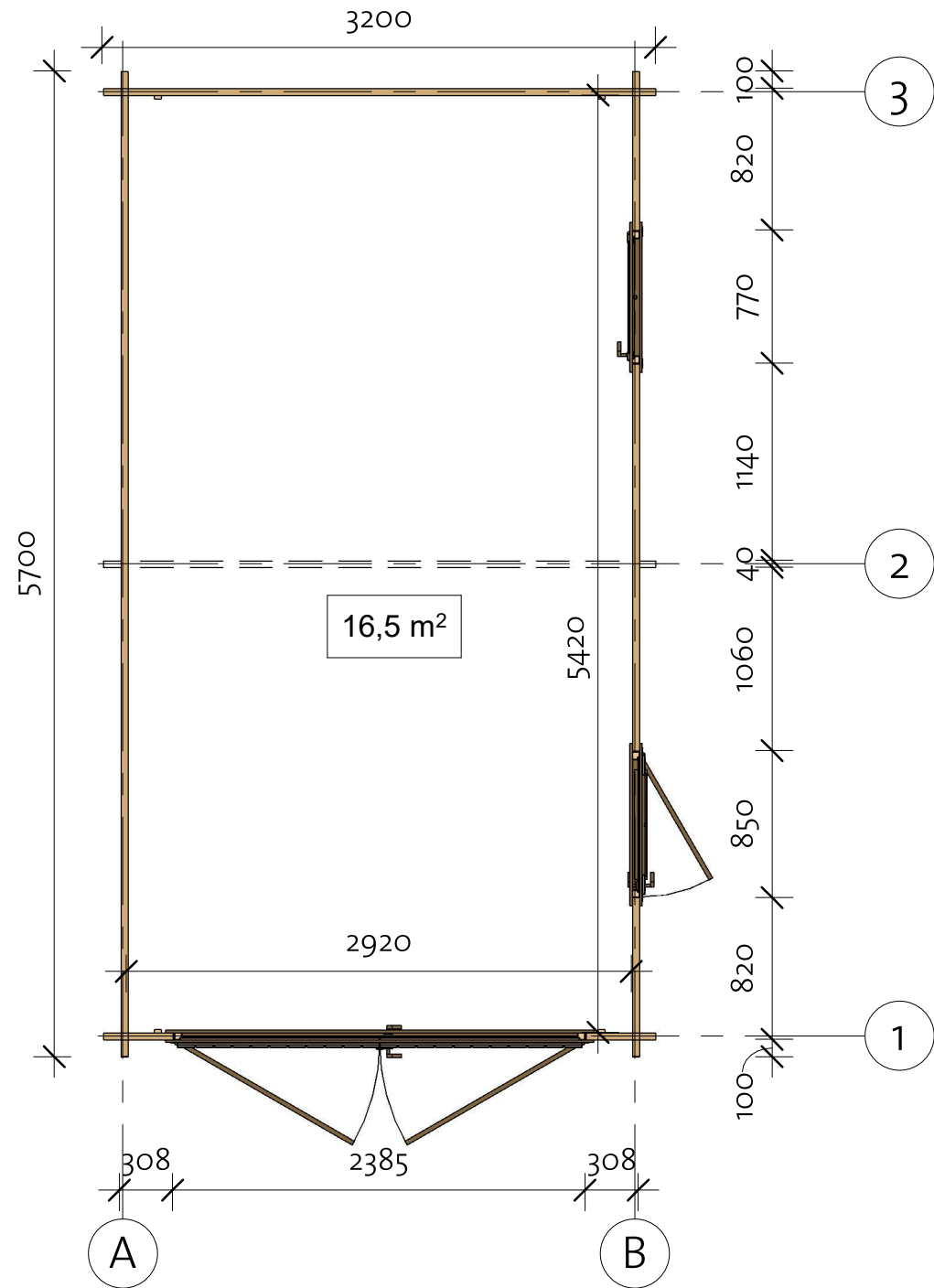

# Nora I 40 (300x550)

Wall 1

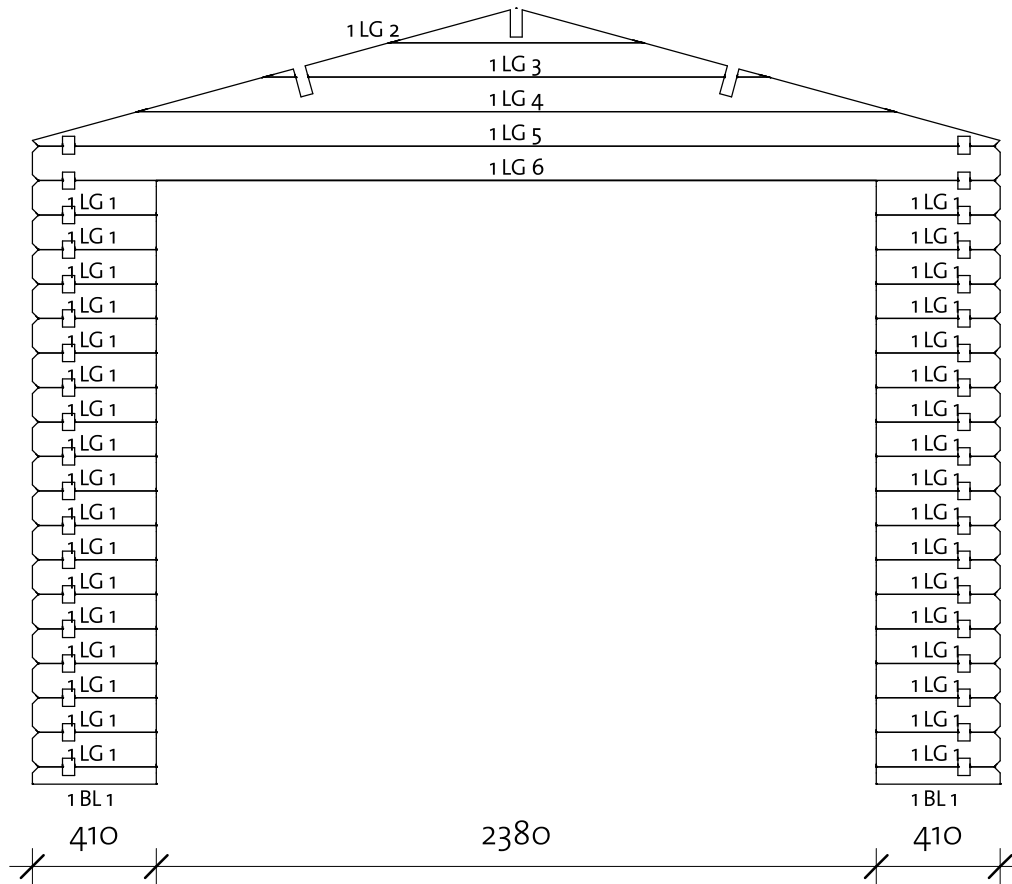
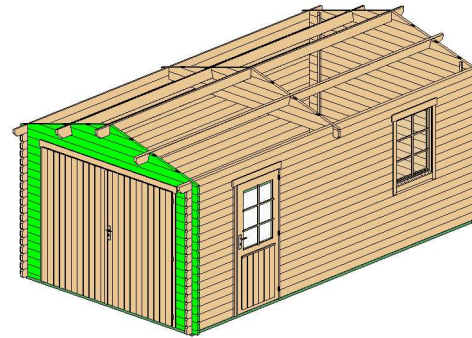

Wall 1			
Mark	Profile	Count	Cut Length

1BL 1	40X57	2	410
1LG 1	40X114	34	410
1LG 2*	40X114	1	836
1LG 3*	40X114	1	1669
1LG 4*	40X114	1	2503
1LG 5*	40X114	1	3198
1LG 6	40X114	1	3200

\* Gable - delivered premounted

Log Profile Wall 1	
Profile	Profile

40X57	
40X114	

# Nora I 40 (300x550)

Wall 2

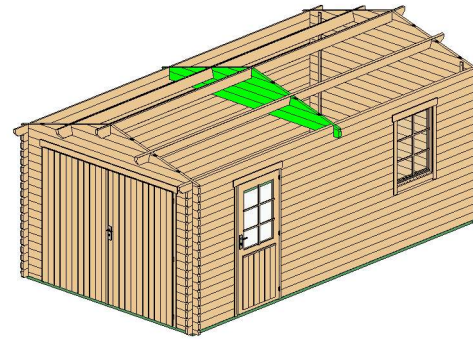

Wall 2			
Mark	Profile	Count	Cut Length

2LG 1*	40x114	1	836
2LG 2*	40x114	1	1669
2LG 3*	40x114	1	2503
2LG 4*	40x114	1	3198
2LG 5	40x114	1	3200

\* Gable - delivered premounted

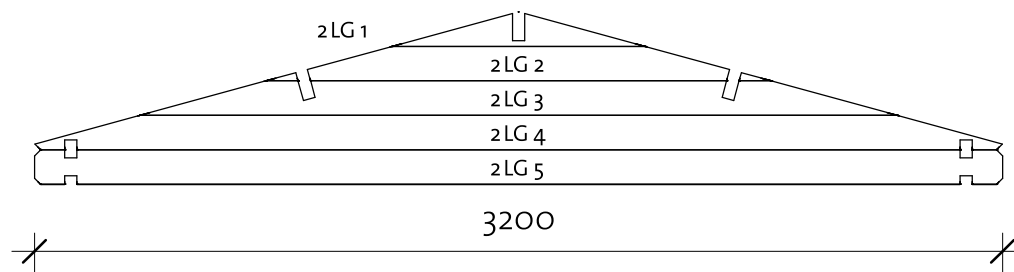

Log Profile Wall 2	
Profile	Profile

40x114	
--------	--

# Nora I 40 (300x550)

Wall 3

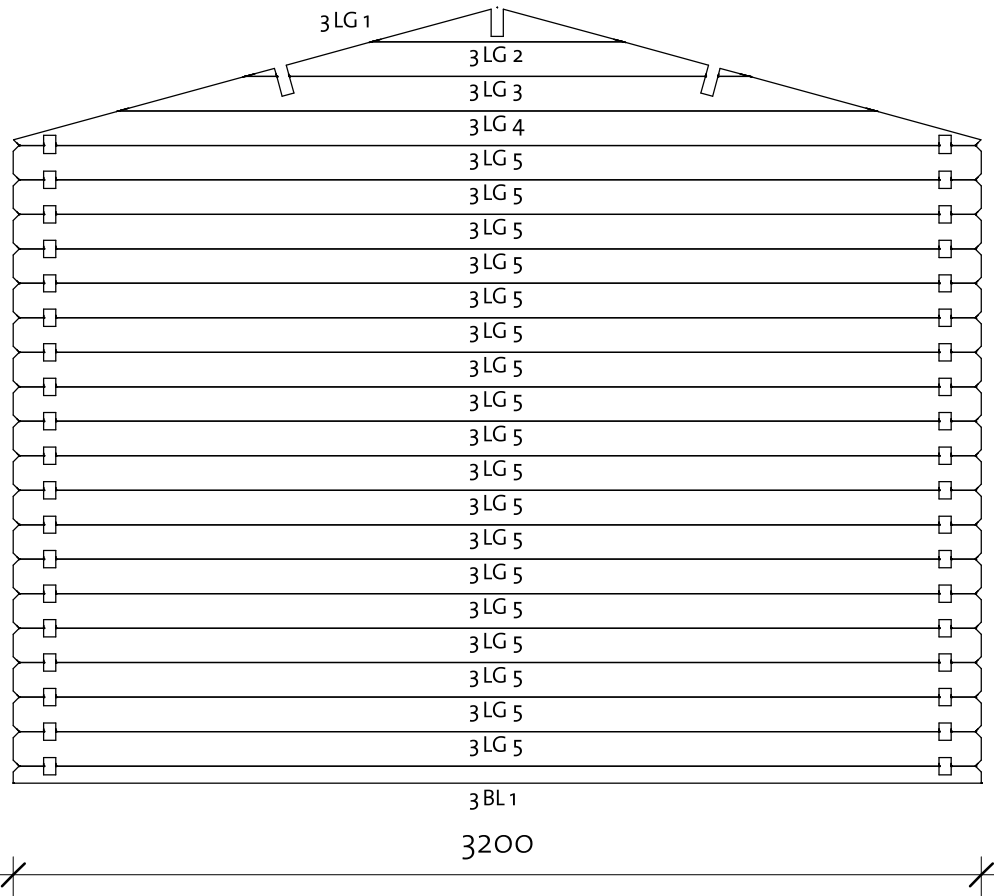
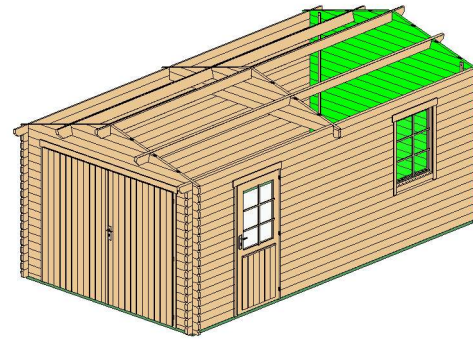

Wall 3			
Mark	Profile	Count	Cut Length

3BL 1	40x57	1	3200
3LG 1*	40x114	1	836
3LG 2*	40x114	1	1669
3LG 3*	40x114	1	2503
3LG 4*	40x114	1	3198
3LG 5	40x114	18	3200

\* Gable - delivered premounted

Log Profile Wall 3	
Profile	Profile

40x57	
40x114	

# Nora I 40 (300x550)

Wall A

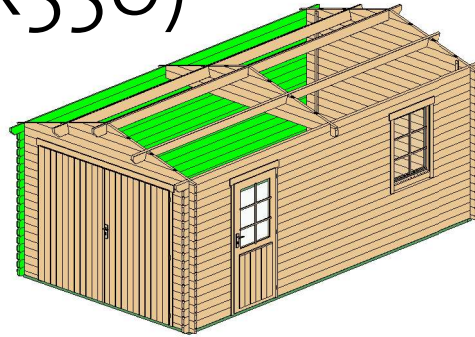

Wall A			
Mark	Profile	Count	Cut Length
ALG2	40x114	1	5700
ALG1	40x114	17	5700
ATL1	40x114	1	5950

Log Profile Wall A	
Profile	Profile
40x114	
40x114	

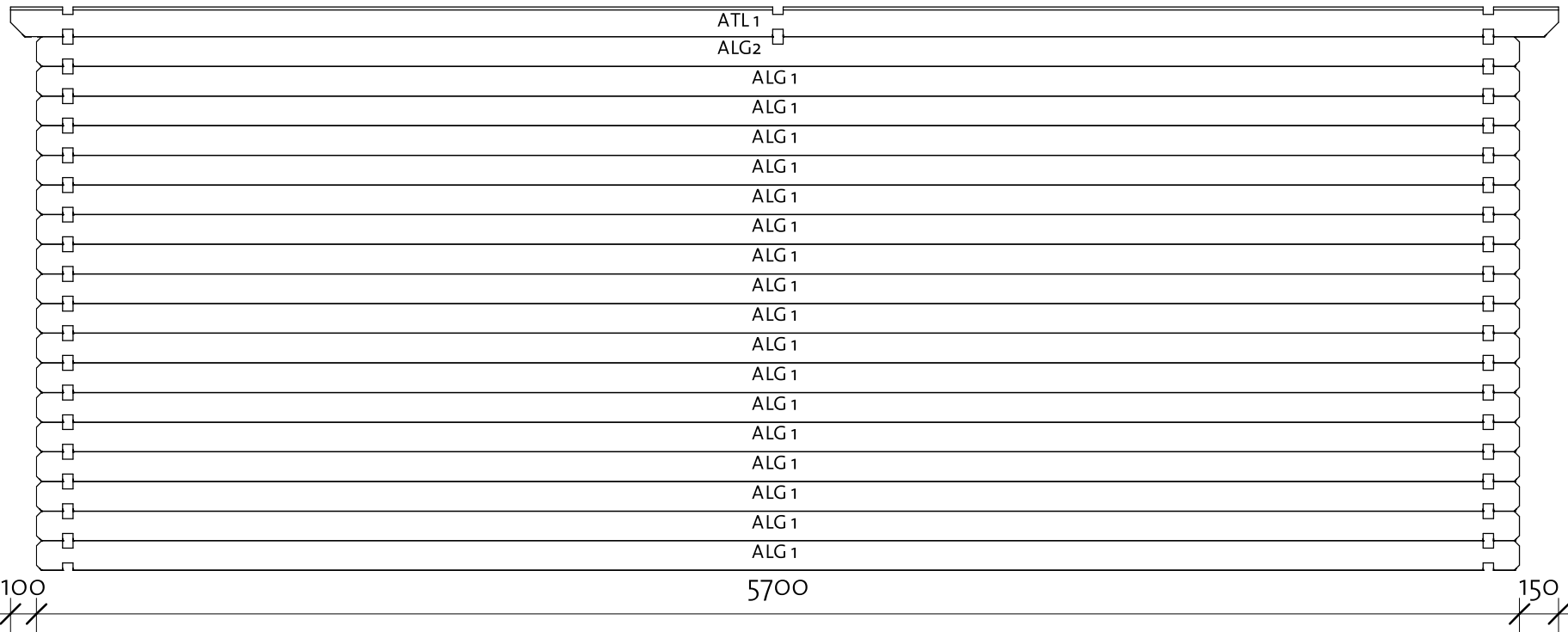

4400001\_191101

# Nora I 40 (300x550)

Wall B



Wall B			
Mark	Profile	Count	Cut Length

BLG 1	40X114	26	920
BLG 2	40X114	9	2240
BLG 3	40X114	8	3930
BLG 4	40X114	1	5700
BTL 1	40X114	1	5950

Log Profile Wall B	
Profile	Profile

40X114	
40X114	

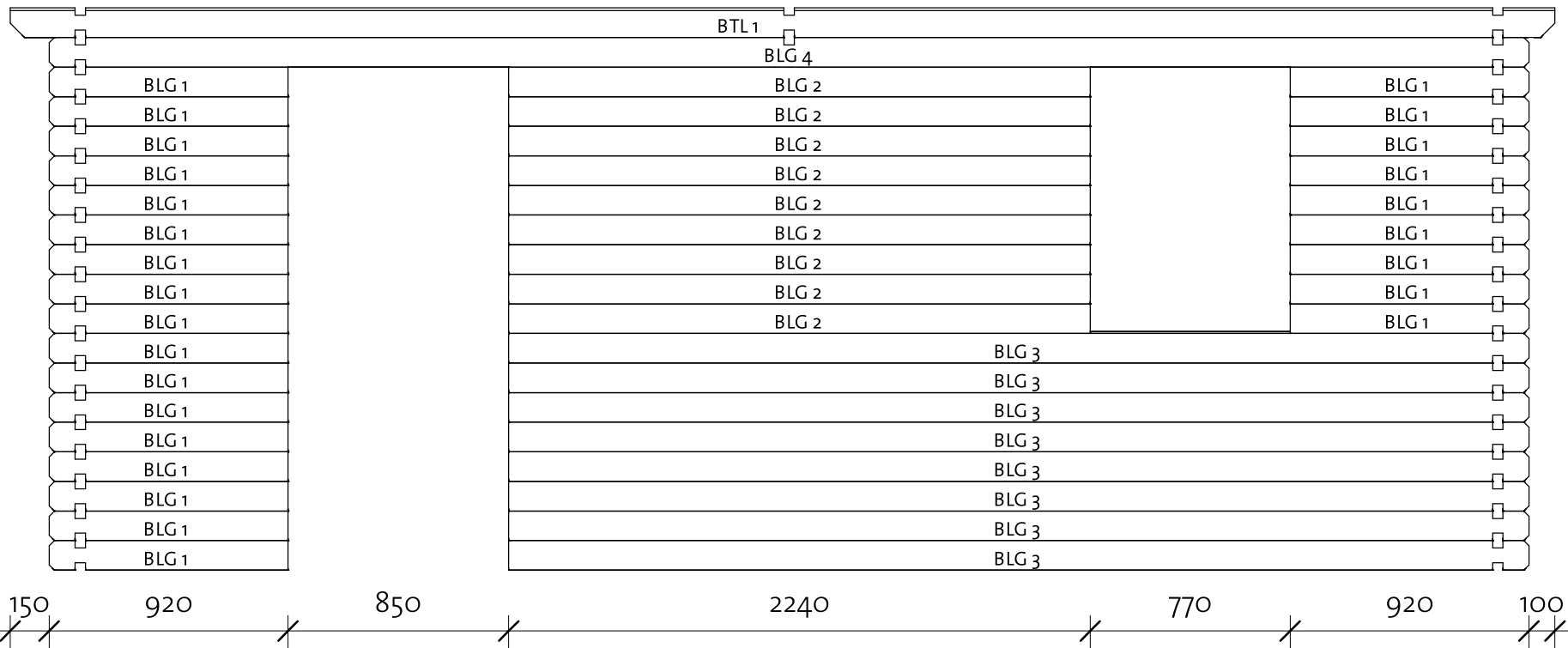





4400001\_191101

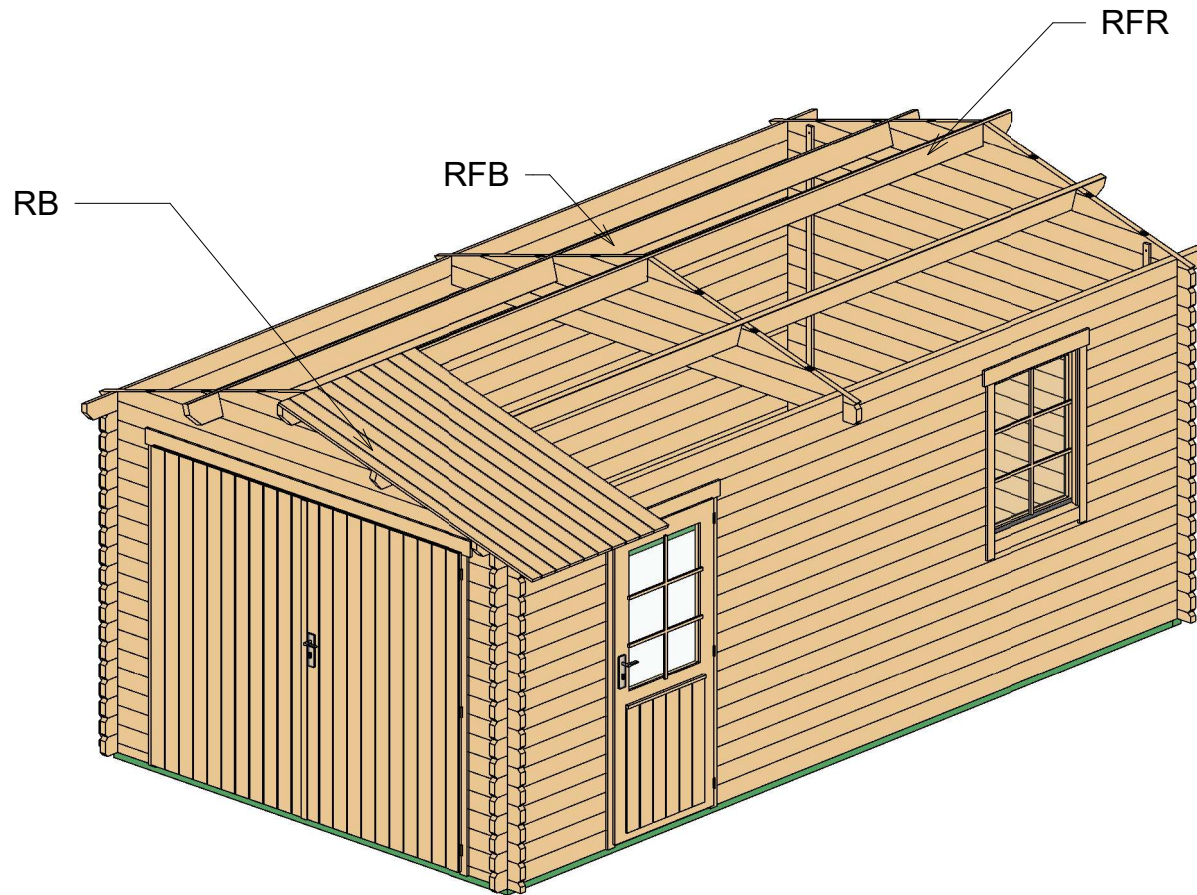

# Nora I 40 (300x550)

Roof 1



Roof				
Mark	Type	Profile	Count	Length
RFR	Ridge 40x143		1	5950
RFB	Beam 40x143		2	5950
RB	17x114		108	2002

# Nora I 40 (300x550)

Roof 2

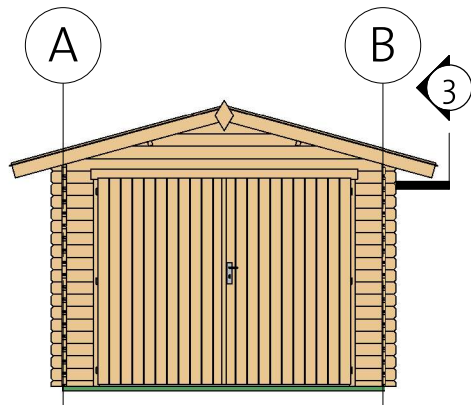
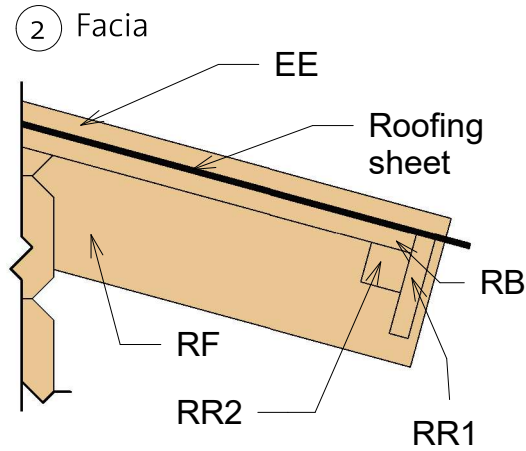
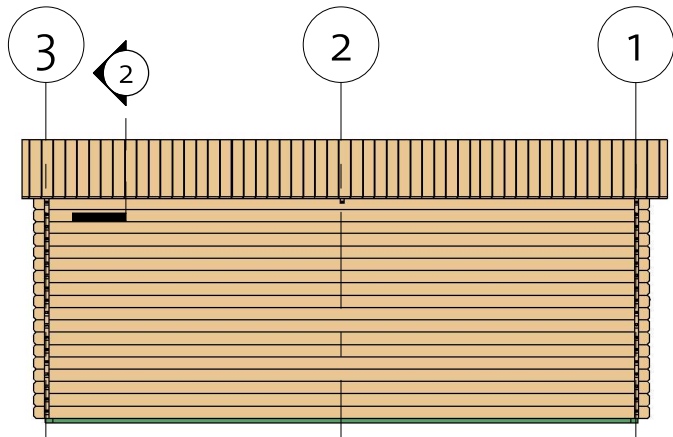



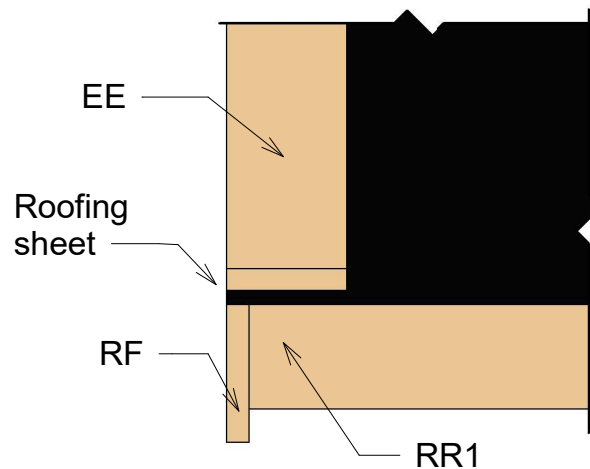









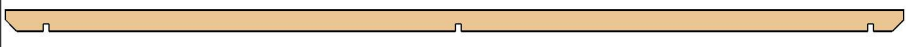

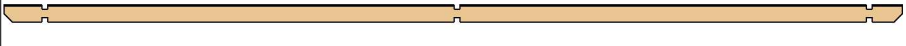

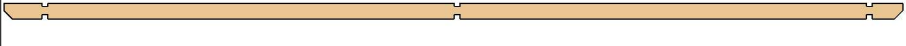

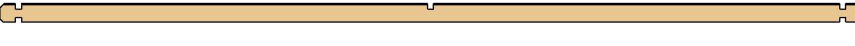

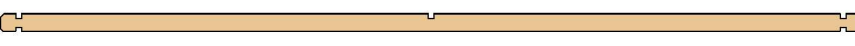





3 Roof Reinforcement



Fascia Schedule				
Mark	Type	Profile	Count	Length
EE	Eave Edging 18x95		4	2034
RF	Roof Fascia 18x120		4	2034
RR1	Roof reinforcement 18x95		2	5950
RR2	Roof reinforcement 38x38		2	5950

# Nora I 40 (300x550)

## List of all items 1

	RFB	Beam 40x143			2	5950
	RFR	Ridge 40x143			1	5950
A	TL 1	Log 40x120			1	5950
B	TL 1	Log 40x120			1	5950
A	LG2	Log 40x114			1	5700
A	LG 1	Log 40x114			17	5700
B	LG 4	Log 40x114			1	5700
	IFB2	IFB 70x40			2	5350
B	LG 3	Log 40x114			8	3930
3	BL 1	Log 40x57			1	3200
2	LG 5	Log 40x114			1	3200
3	LG 5	Log 40x114			18	3200
1	LG 6	Log 40x114			1	3200
	IFB1	IFB 70x40			2	2990
B	LG 2	Log 40x114			9	2240
	RB	17x114			108	2002
B	LG 1	Log 40x114			26	920
1	BL 1	Log 40x57			2	410
1	LG 1	Log 40x114			34	410

# Nora I 40 (300x550)

## List of all items 2

① Gable 1

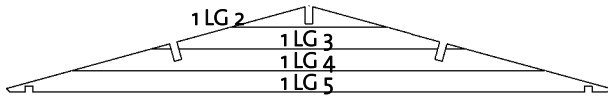

② Gable 2

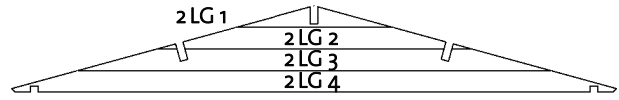

③ Gable 3

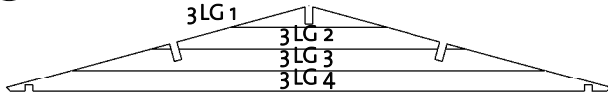

RR1	Roof reinforcement 18x95		2	5950
RR2	Roof reinforcement 38x38		2	5950
EE	Eave Edging 18x95		4	2034
RF	Roof Fascia 18x120		4	2034

Windboard 18x40		4	2200
-----------------	--	---	------

Romb	2
------	---



CDD10R	Classic double door 10, wood right		2370	1955	1
CD1R	Classic door 1 right		840	1890	1

DCB6	Door crossbar 6	--	--	1
------	-----------------	----	----	---

CW1L	Classic window 1 left		765	990	1
------	-----------------------	--	-----	-----	---

WCB6	Window crossbar 6	--	--	1
------	-------------------	----	----	---

Hitblock	300-400 mm		
Door bolt	315 x 65		2
Screws	5,0 x 70		10
Bolts	M8 x 70		12
Screws	5,0 x 40		16
Screws	6,0 x 140		40
Screws	4,0 x 40		100
Screws	4,0 x 50		350