

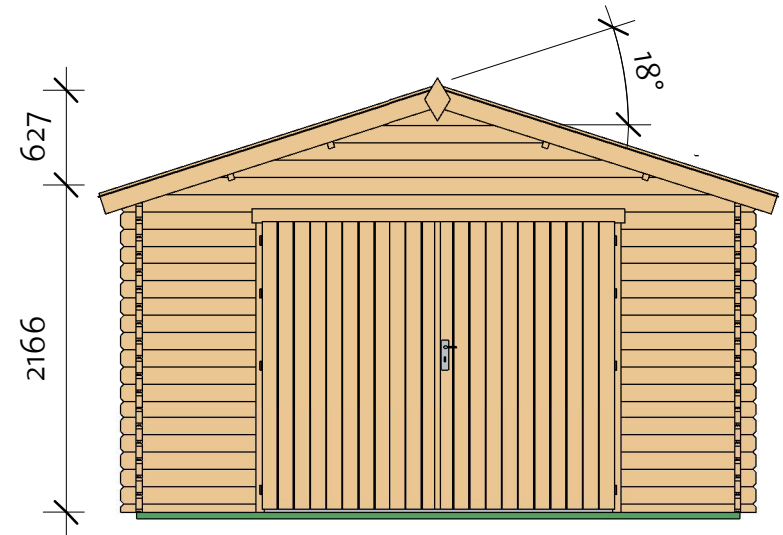

Garage Newport 40 (400x499)

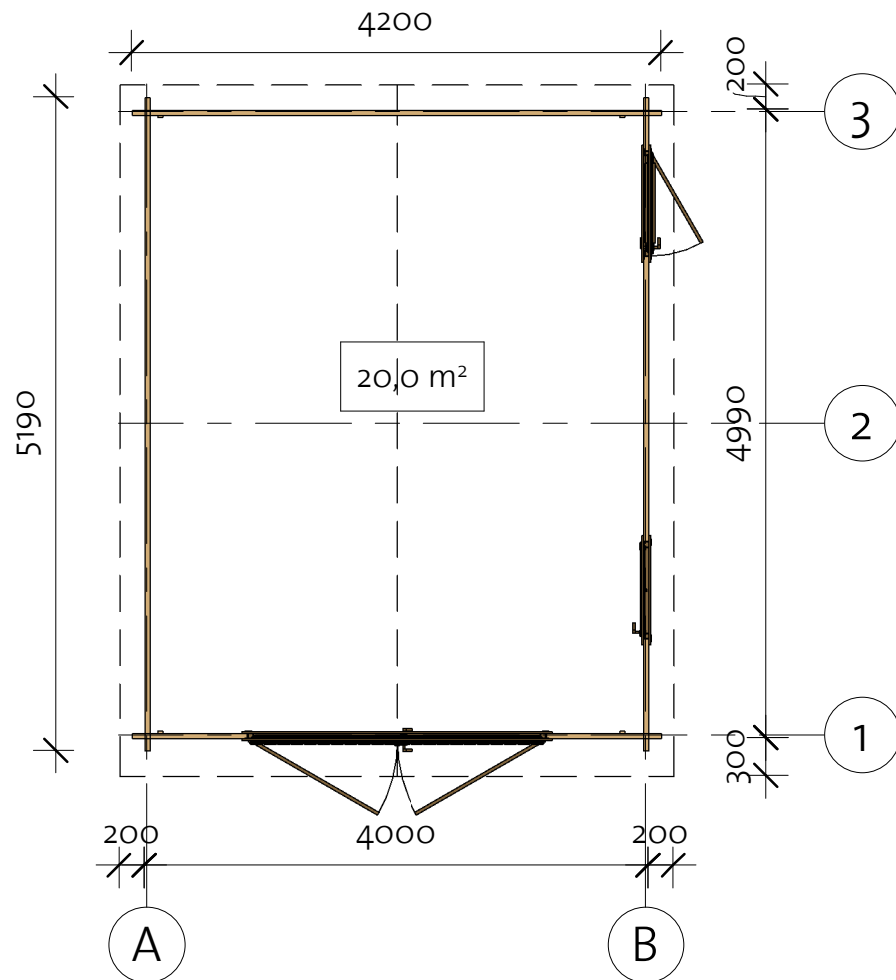
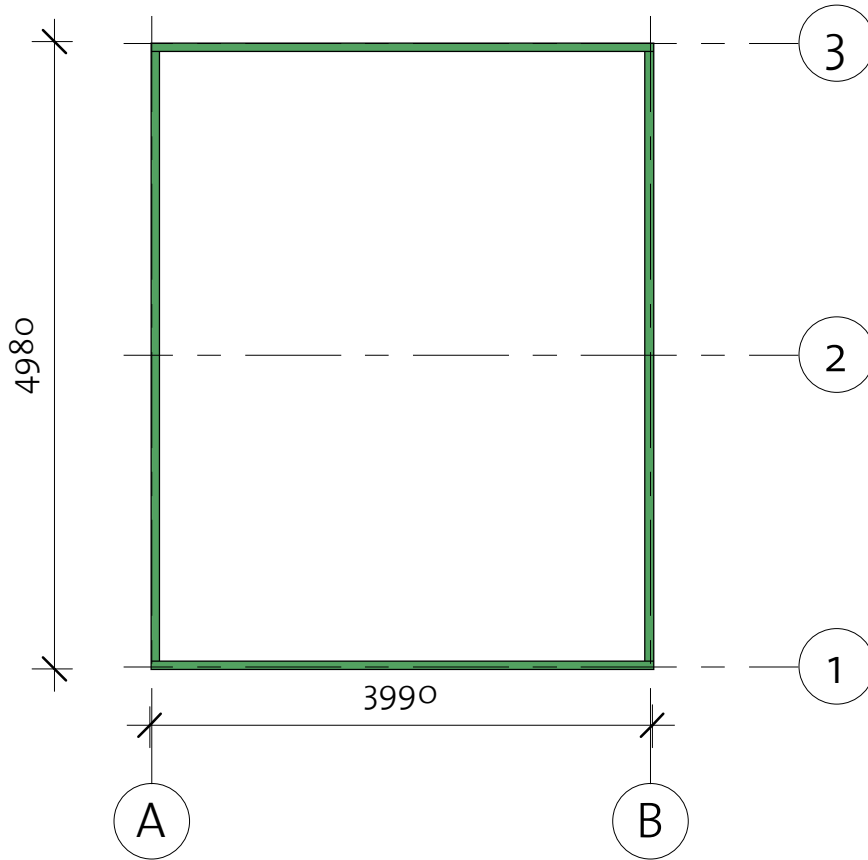

Garage Newport 40 (400x499)

Foundation



Impregnated foundation beams				
Mark	Type	Profile	Count	Length
IFB1	IFB 70x40		2	3990
IFB2	IFB 70x40		2	4840

Garage Newport 40 (400x499)

Wall 1

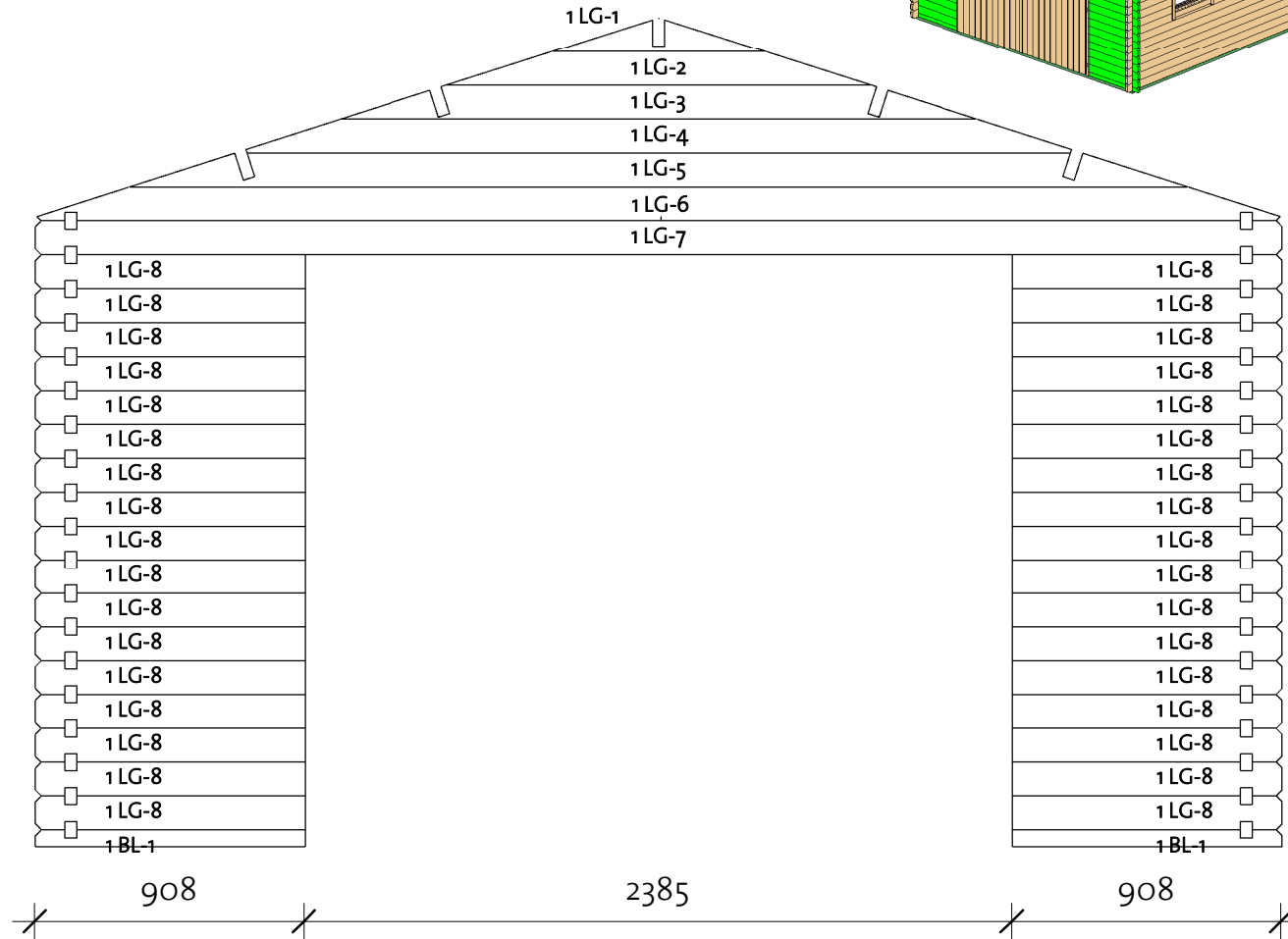
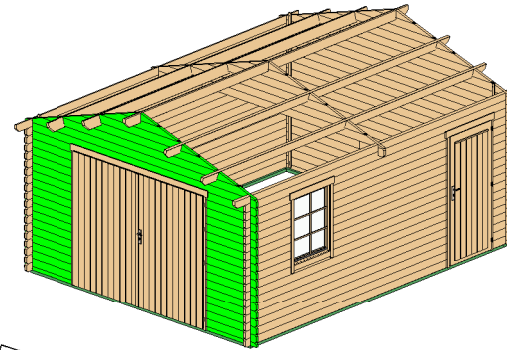



Wall 1			
Mark	Profile	Count	Cut Length

1BL-1	40X57	2	908
1LG-1*	40X114	1	715
1LG-2*	40X114	1	1427
1LG-3*	40X114	1	2139
1LG-4*	40X114	1	2783
1LG-5*	40X114	1	3564
1LG-6*	40X114	1	4188
1LG-7	40X114	1	4200
1LG-8	40X114	34	908

* Gable - delivered premounted

Log Profile Wall 1	
Profile	Profile

40X57	
40X114	

Garage Newport 40 (400x499)

Wall 2

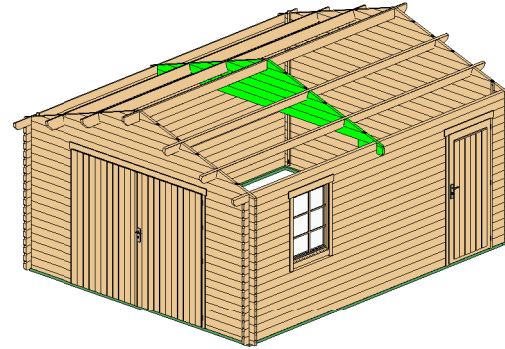

Wall 2

Mark	Profile	Count	Cut Length
------	---------	-------	------------

2LG 1 *	40X114	1	715
2LG 2 *	40X114	1	1427
2LG 3 *	40X114	1	2139
2LG 4 *	40X114	1	2783
2LG 5 *	40X114	1	3564
2LG 6 *	40X114	1	4188
2LG 7	40X114	2	440

* Gable - delivered premounted

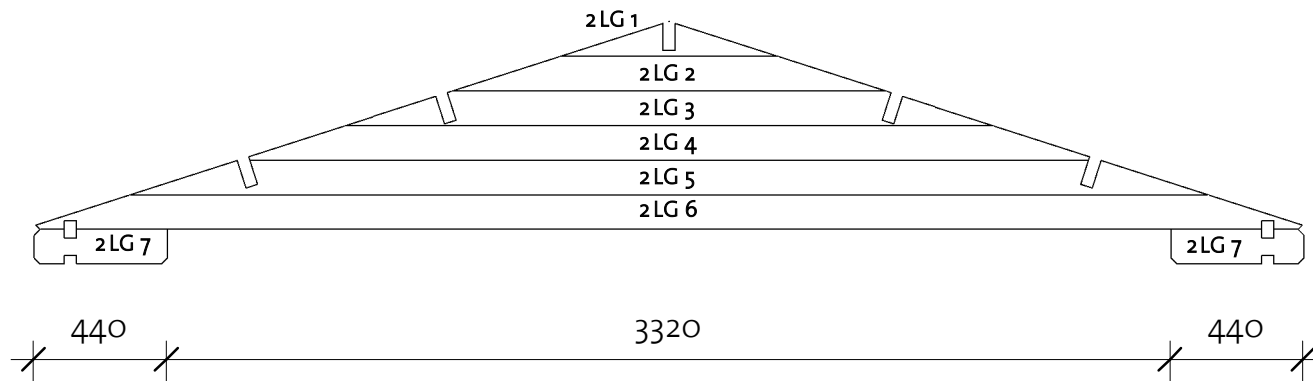

Log Profile Wall 2

Profile	Profile
---------	---------

40X114

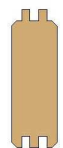

Garage Newport 40 (400x499)

Wall 3

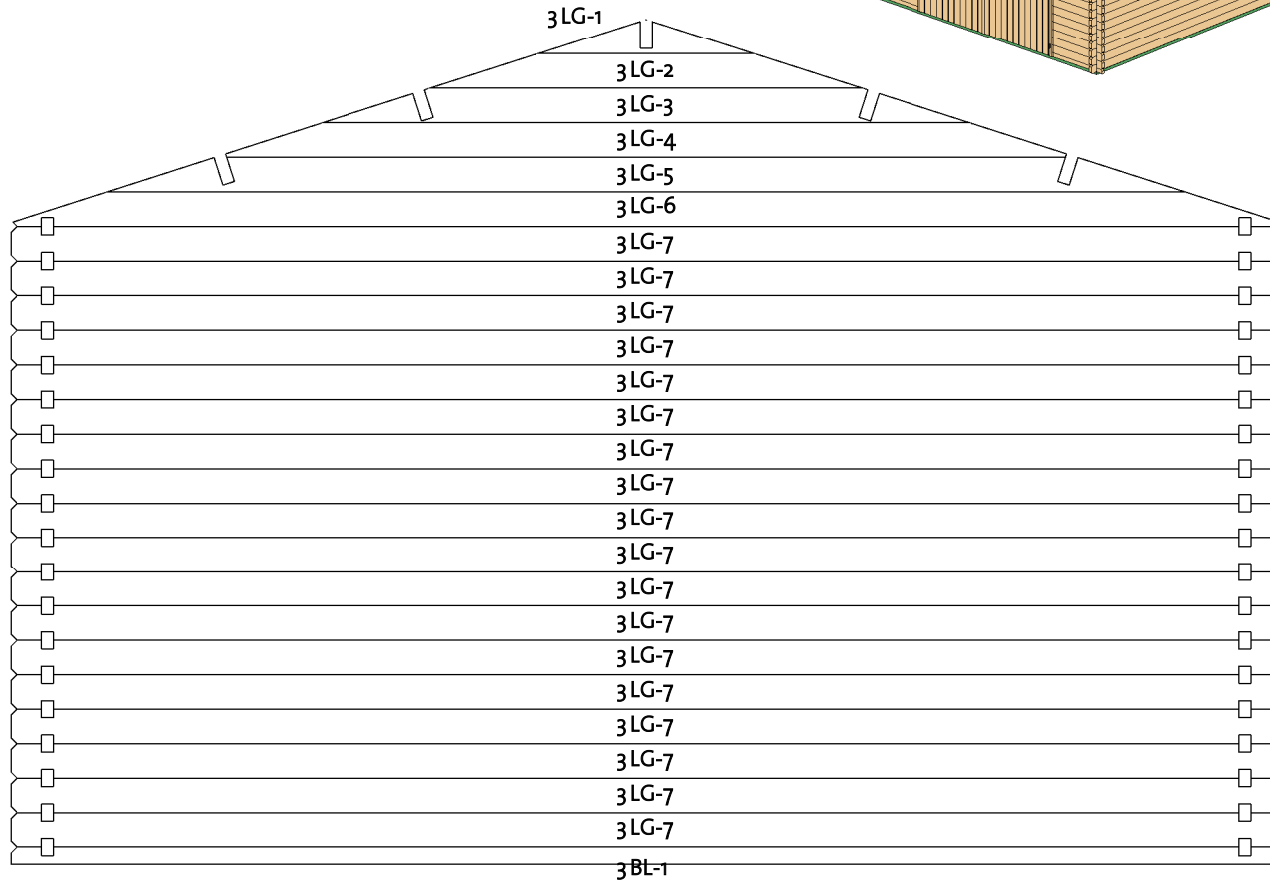
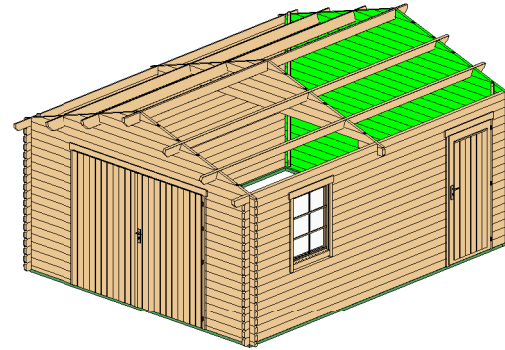

Wall 3			
Mark	Profile	Count	Cut Length

3BL-1	40x57	1	4200
3LG-1*	40x114	1	715
3LG-2*	40x114	1	1427
3LG-3*	40x114	1	2139
3LG-4*	40x114	1	2783
3LG-5*	40x114	1	3564
3LG-6*	40x114	1	4188
3LG-7	40x114	18	4200

* Gable - delivered premounted

Log Profile Wall 3	
Profile	Profile

40x57	
40x114	

Garage Newport 40 (400x499)

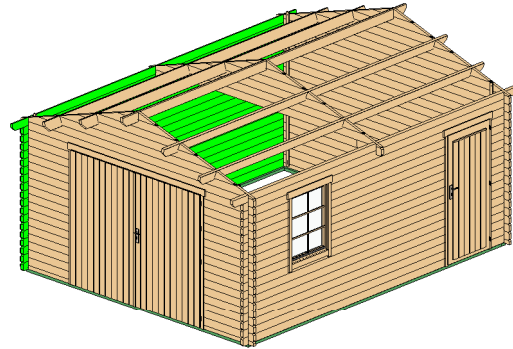

Wall A



Wall A			
Mark	Profile	Count	Cut Length

ALG-1	40x114	17	5190
ALG-2	40x114	1	5190
ATL-1	40x114	1	5490

Log Profile Wall A	
Profile	Profile

40x114	
40x114	

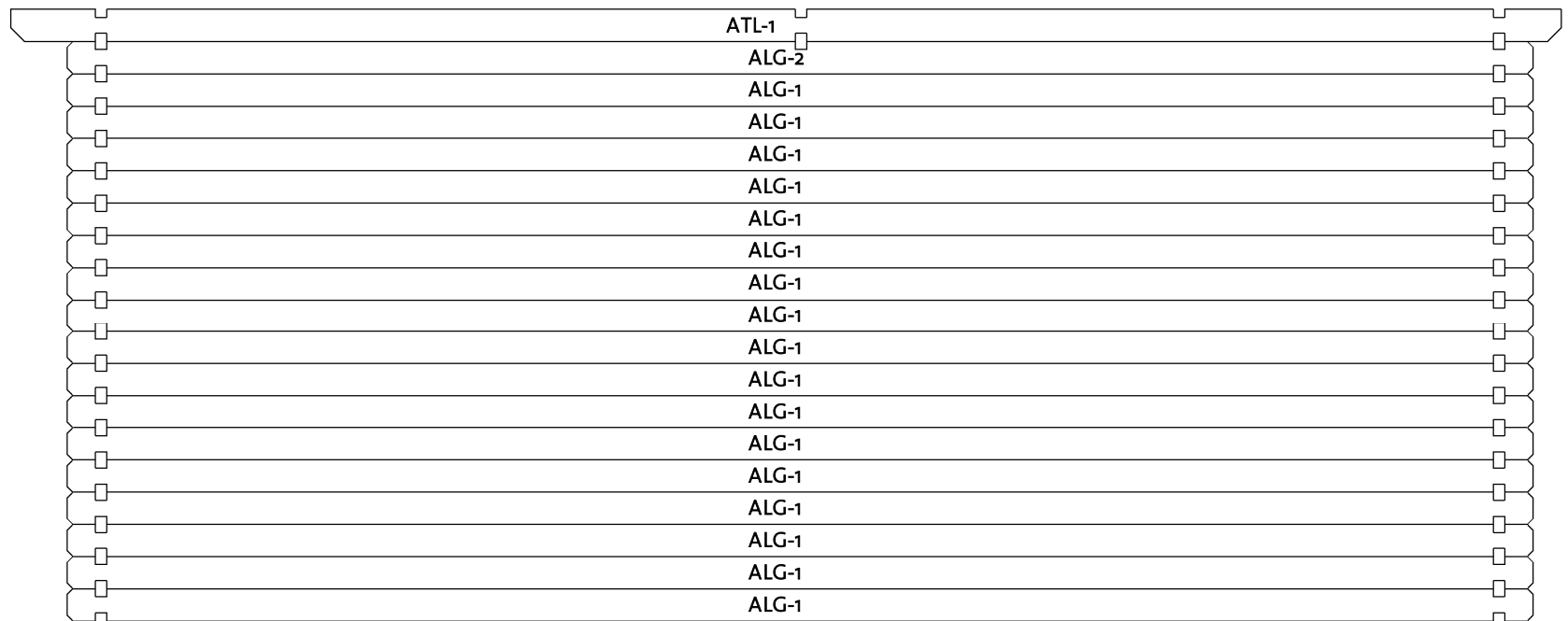

200

5190

100

92110281_211028

Garage Newport 40 (400x499)

Wall B

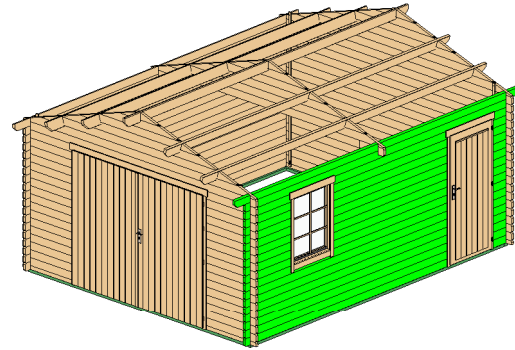

Wall B			
Mark	Profile	Count	Cut Length

BLG-1	40X114	17	420
BLG-2	40X114	1	5190
BLG-3	40X114	9	900
BLG-4	40X114	9	2250
BLG-5	40X114	8	3920
BTL-1	40X114	1	5490

Log Profile Wall B	
Profile	Profile

40X114	
40X114	

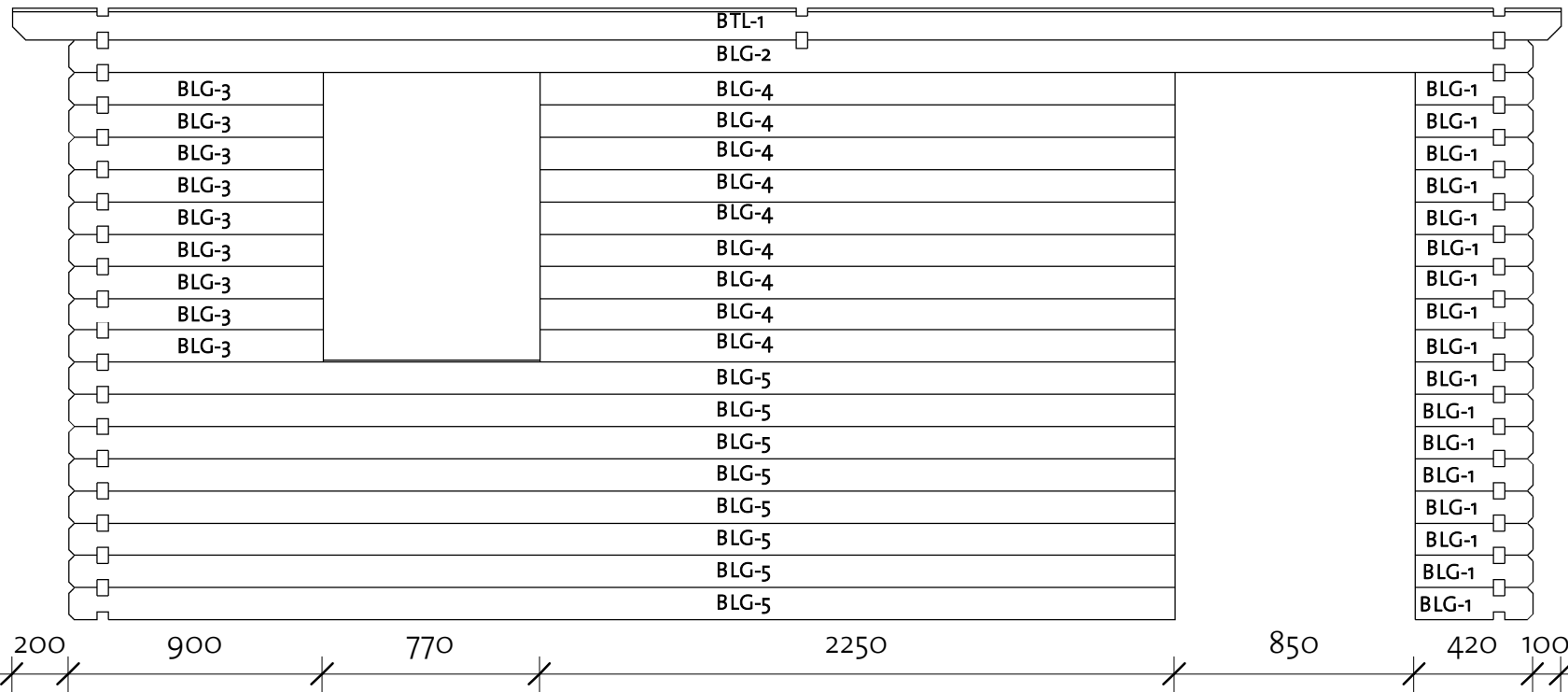



92110281_211028

Garage Newport 40 (400x499)

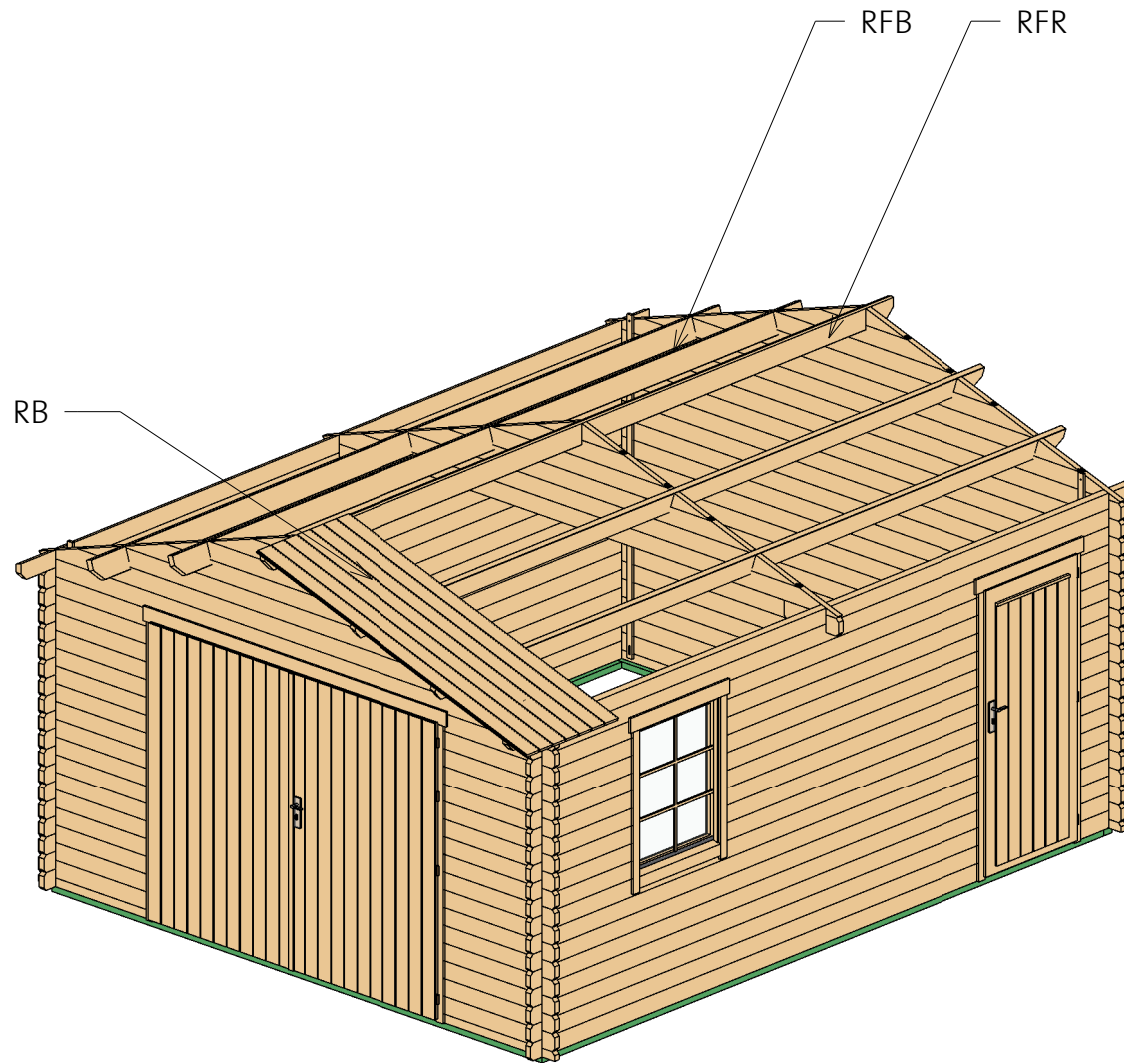
Roof 1



Roof				
Mark	Type	Profile	Count	Length
RB	17x114		98	2304
RFB	Beam 40x143		4	5490
RFR	Ridge 40x143		1	5490

Garage Newport 40 (400x499)

Roof 2

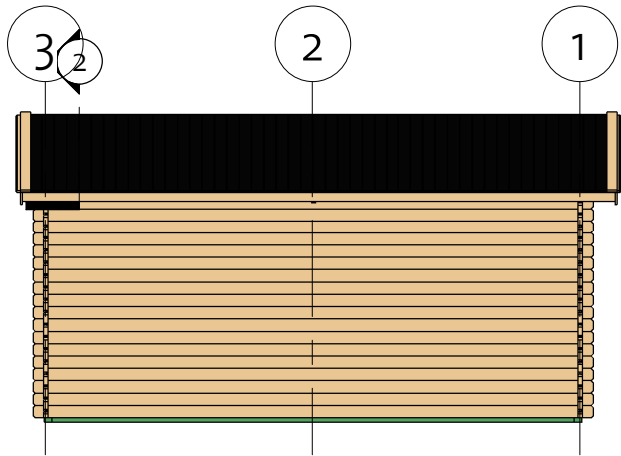

② Fascia

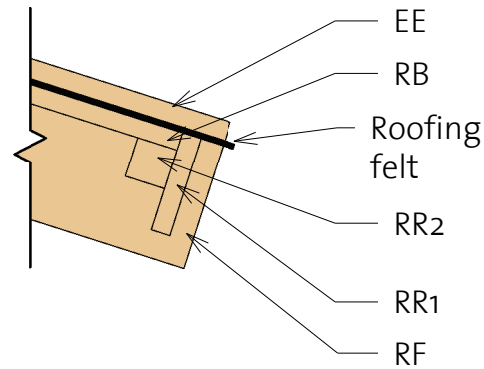

③ Roof Reinforcement

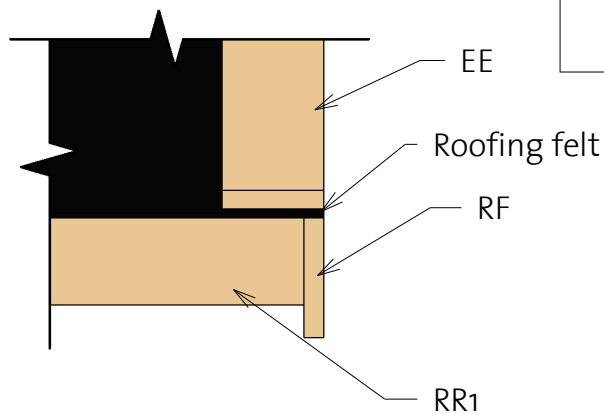
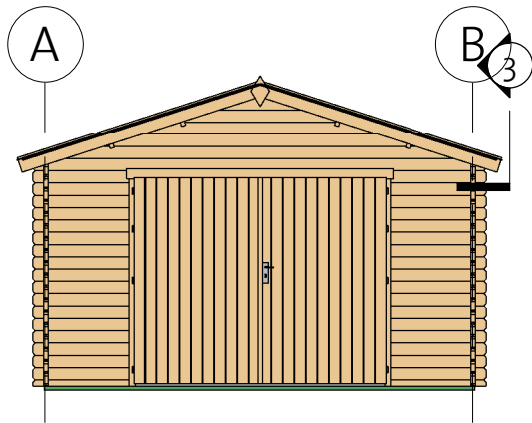

Fascia Schedule				
Mark	Type	Profile	Count	Length
EE	Eave Edging 18x95		4	2350
RF	Roof Fascia 18x120		4	2350
RR1	Roof reinforcement 18x95		2	5490
RR2	Roof reinforcement 38x38		2	5490

Garage Newport 40 (400x499)

Extras

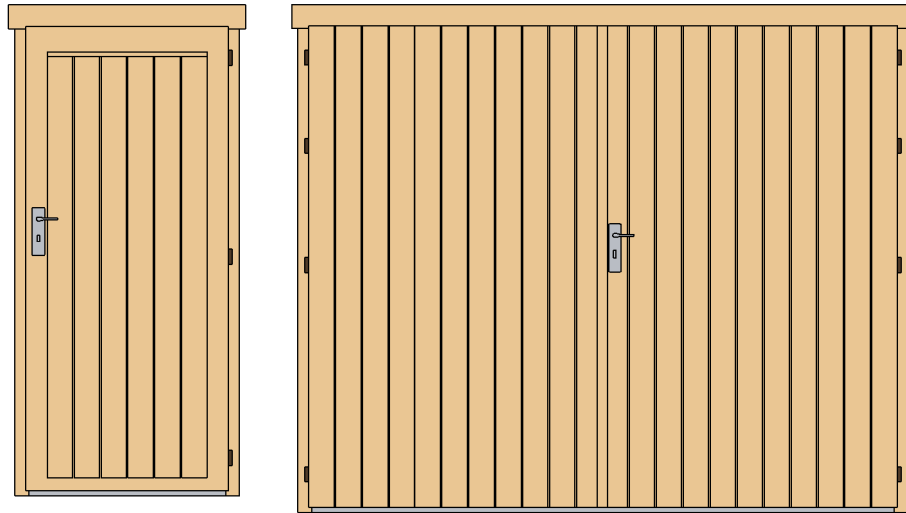

Door Schedule				
Mark	Type	Width	Height	Count
CD5R	Classic door 5, wood right	840	1890	1
CDD10R	Classic double door 10, wood right	2370	1955	1

Fasteners/Extras		
Name	Type	Count

Hitblock	300-400 mm	
Door bolt	315 x 65	2
Bolts	M8 x 70	12
Screws	5,0 x 70	15
Screws	5,0 x 40	16
Screws	6,0 x 140	50
Screws	4,0 x 40	90
Screws	4,0 x 50	410

Type	Count	Length
------	-------	--------

Windboard 18x40	4	2200
-----------------	---	------

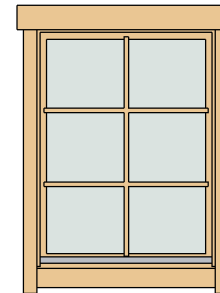

Window Schedule				
Mark	Type	Width	Height	Count

CW1L	Classic window 1 left	765	990	1
------	-----------------------	-----	-----	---

WCB6	Windows Crossbar 6	--	--	1
------	--------------------	----	----	---

Family	Count
--------	-------

Romb	2
------	---



Garage Newport 40 (400x499)

List of all items 1





Impregnated foundation beams

Mark	Type	Profile	Count	Length
------	------	---------	-------	--------

IFB1	IFB 70x40		2	3990
IFB2	IFB 70x40		2	4840



Fascia Schedule

Mark	Type	Profile	Count	Length
------	------	---------	-------	--------

EE	Eave Edging 18x95		4	2350
RF	Roof Fascia 18x120		4	2350
RR1	Roof reinforcement 18x95		2	5490
RR2	Roof reinforcement 38x38		2	5490

Roof

Mark	Type	Profile	Count	Length
------	------	---------	-------	--------

RB	17x114		98	2304
RFB	Beam 40x143		4	5490
RFR	Ridge 40x143		1	5490

Garage Newport 40 (400x499)

List of all items 2

Wall 1			
Mark	Profile	Count	Cut Length

1BL-1	40X57	2	908
1LG-1*	40X114	1	715
1LG-2*	40X114	1	1427
1LG-3*	40X114	1	2139
1LG-4*	40X114	1	2783
1LG-5*	40X114	1	3564
1LG-6*	40X114	1	4188
1LG-7	40X114	1	4200
1LG-8	40X114	34	908

Wall 3			
Mark	Profile	Count	Cut Length

3BL-1	40X57	1	4200
3LG-1*	40X114	1	715
3LG-2*	40X114	1	1427
3LG-3*	40X114	1	2139
3LG-4*	40X114	1	2783
3LG-5*	40X114	1	3564
3LG-6*	40X114	1	4188
3LG-7	40X114	18	4200

*Gable-delivered premounted

Wall 2			
Mark	Profile	Count	Cut Length

2LG 1*	40X114	1	715
2LG 2*	40X114	1	1427
2LG 3*	40X114	1	2139
2LG 4*	40X114	1	2783
2LG 5*	40X114	1	3564
2LG 6*	40X114	1	4188
2LG 7	40X114	2	440

Wall A			
Mark	Profile	Count	Cut Length

ALG-1	40X114	17	5190
ALG-2	40X114	1	5190
ATL-1	40X114	1	5490

Wall B			
Mark	Profile	Count	Cut Length

BLG-1	40X114	17	420
BLG-2	40X114	1	5190
BLG-3	40X114	9	900
BLG-4	40X114	9	2250
BLG-5	40X114	8	3920
BTL-1	40X114	1	5490

Log Profiles	
Profile	Profile

40X57	
-------	-------------------------------------------------------------------------------------

Log Profiles	
Profile	Profile

40X114	
--------	-------------------------------------------------------------------------------------

Log Profiles	
Profile	Profile

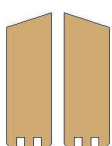
40X114	
--------	---------------------------------------------------------------------------------------