

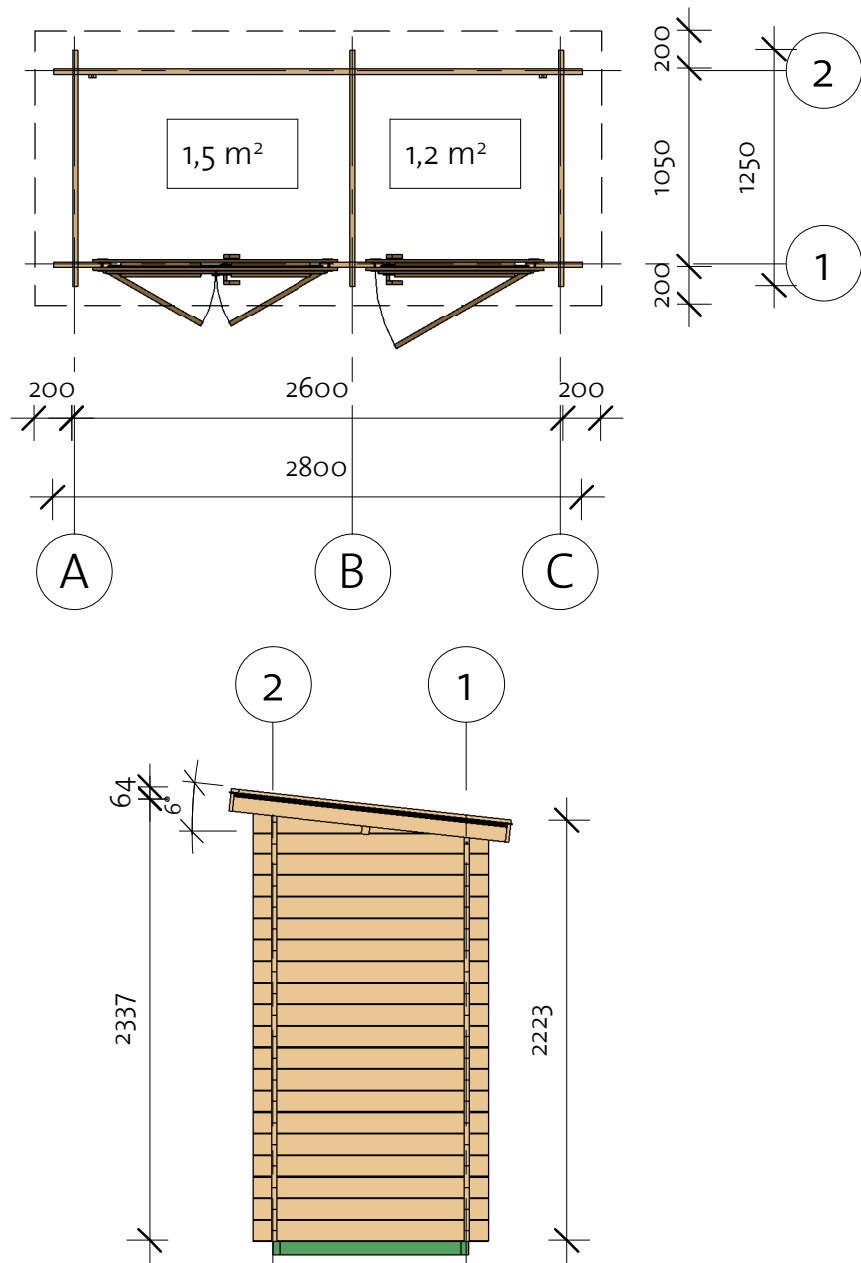

Waste House 28 (260x105)

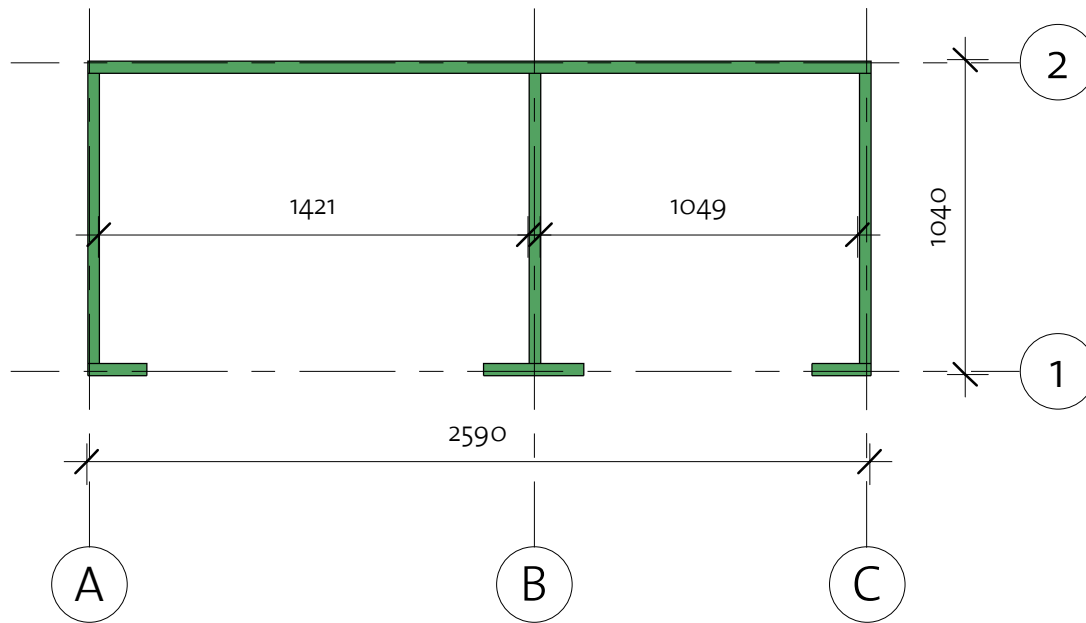

Waste House 28 (260x105)

Foundation



Impregnated foundation beams				
Mark	Type	Profile	Count	Length
IFB1	IFB 40x70		1	2590
IFB2	IFB 40x70		3	960
IFB3	IFB 40x70		2	195
IFB4	IFB 40x70		1	330

Waste House 28 (260x105)

Floor Plan

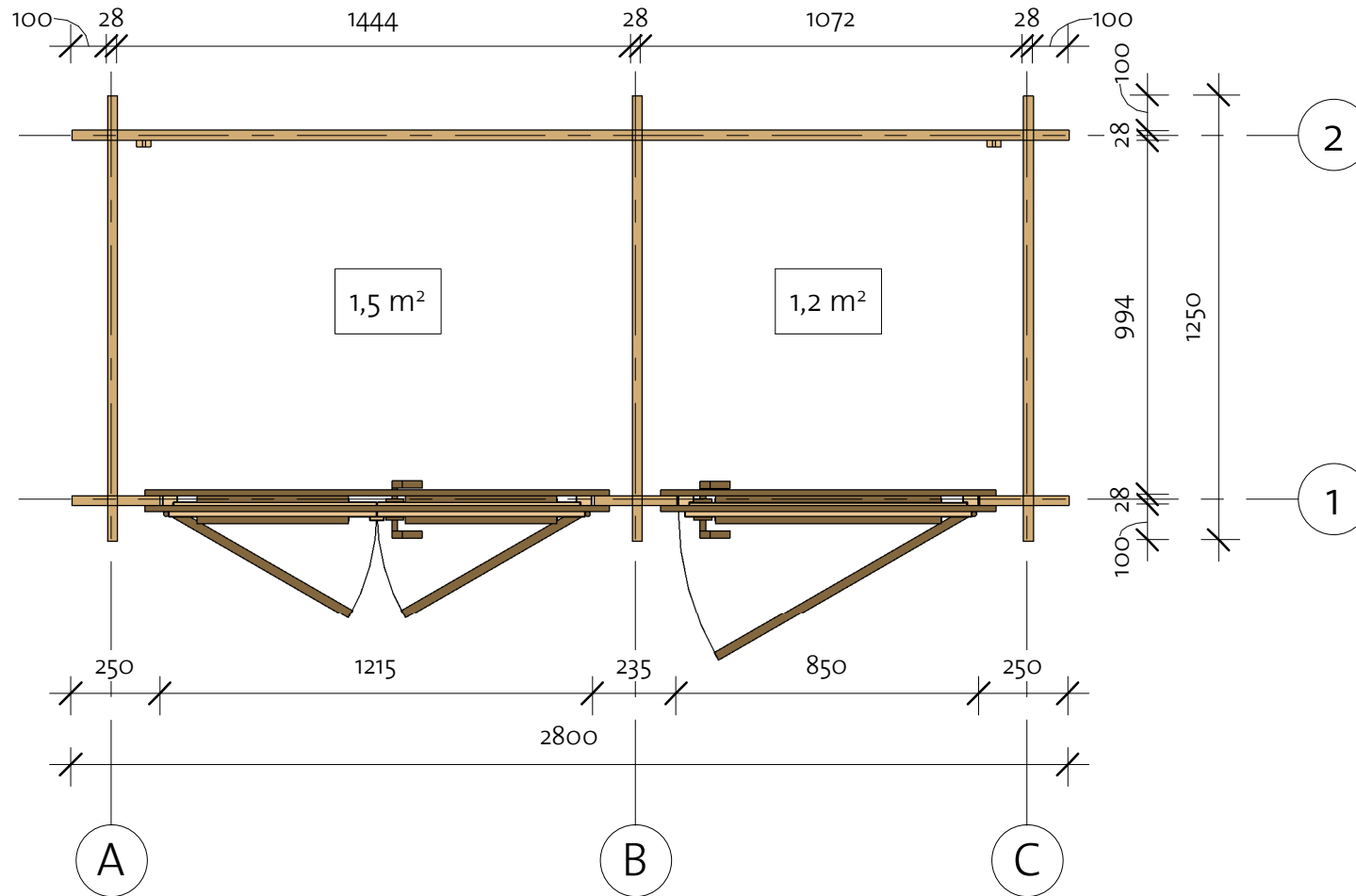

Waste House 28 (260x105)

Wall 1

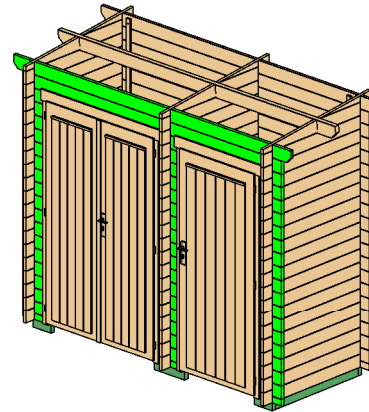

Wall 1			
Mark	Profile	Count	Cut Length

1BL-1	28x57	1	235
1BL-2	28x57	2	250
1LG-1	28x114	17	235
1LG-2	28x114	34	250
1LG-3	28x114	1	2800
1TL-1	28x114	1	3000

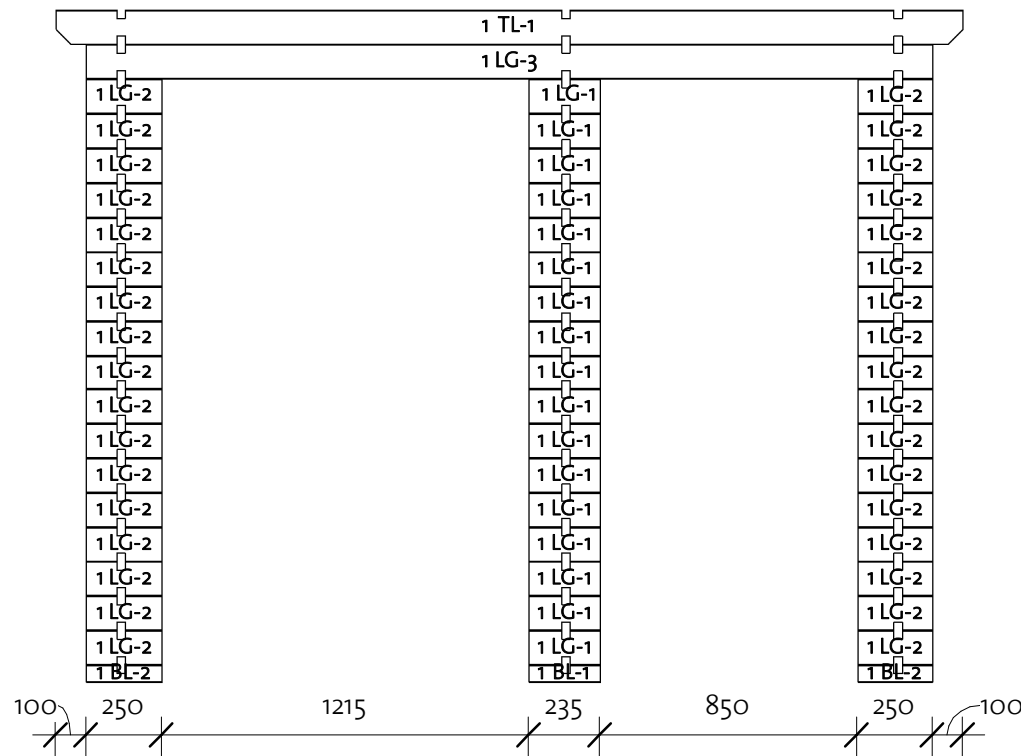

Log Profile Wall 1	
Profile	Profile

28x57	
28x114	
28x114	

Waste House 28 (260x105)

Wall 2

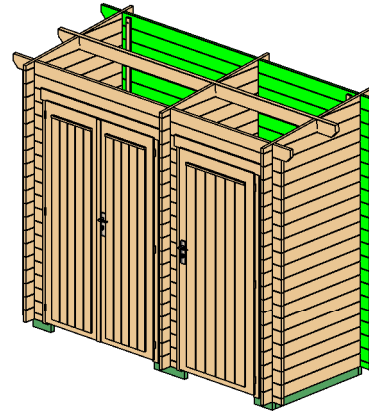

Wall 2			
Mark	Profile	Count	Cut Length
2BL-1	28x57	1	2800
2LG-1	28x114	19	2800
2TL-1	28x114	1	3000

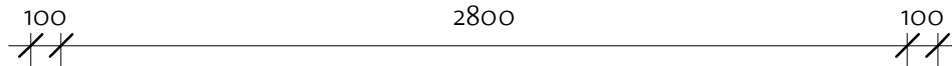
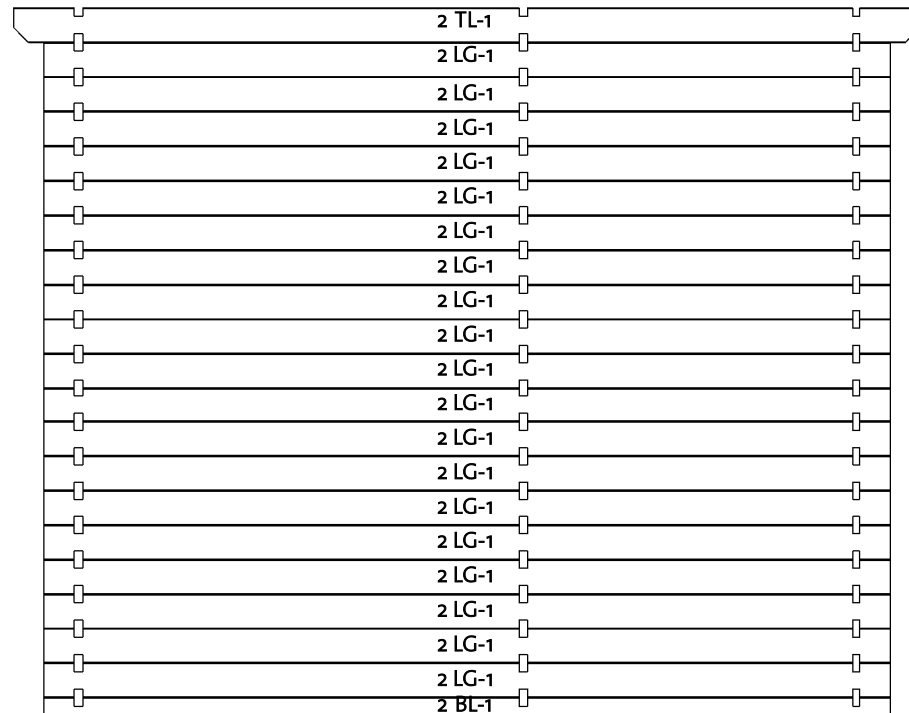

Log Profile Wall 2	
Profile	Profile

28x57	
28x114	
28x114	

Waste House 28 (260x105)

Wall A

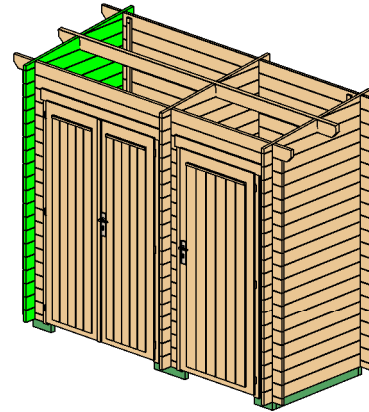

Wall A			
Mark	Profile	Count	Cut Length

ALG-1*	28x114	1	593
ALG-2	28x114	19	1250
ALG-3*	28x114	1	1250

* Gable - delivered premounted

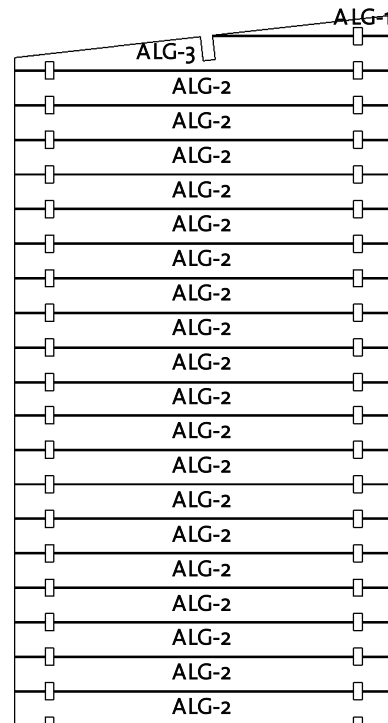

Log Profile Wall A	
Profile	Profile

28x114	
--------	---

Waste House 28 (260x105)

Wall B

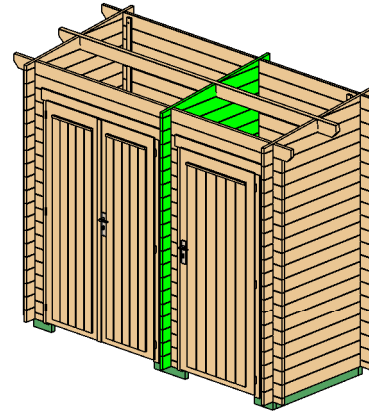

Wall B			
Mark	Profile	Count	Cut Length
BLG-1*	28x114	1	593
BLG-2	28x114	19	1250
BLG-3*	28x114	1	1250

* Gable - delivered premounted

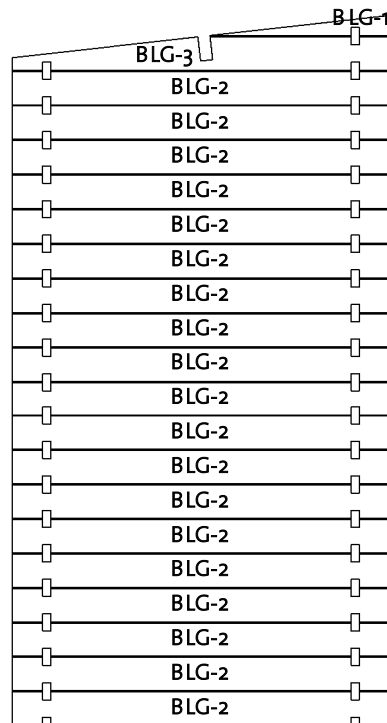

Log Profile Wall B	
Profile	Profile

28x114	
--------	--

Waste House 28 (260x105)

Wall C

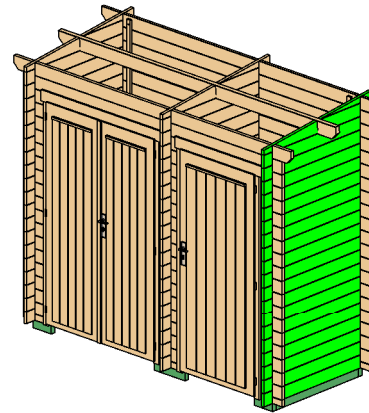

Wall C			
Mark	Profile	Count	Cut Length

CLG-1*	28x114	1	593
CLG-2	28x114	19	1250
CLG-3*	28x114	1	1250

* Gable - delivered premounted

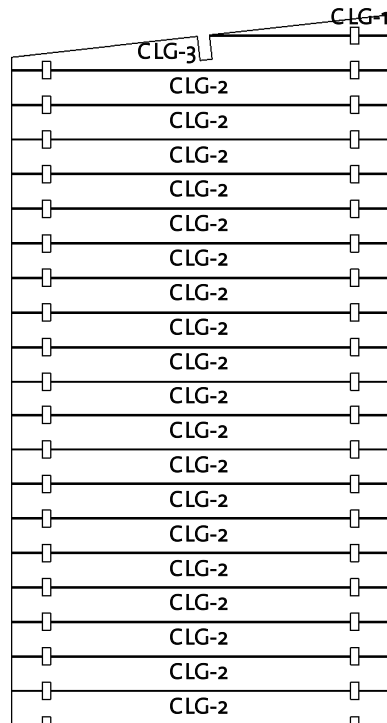



Log Profile Wall C	
Profile	Profile

28x114	
--------	--

Waste House 28 (260x105)

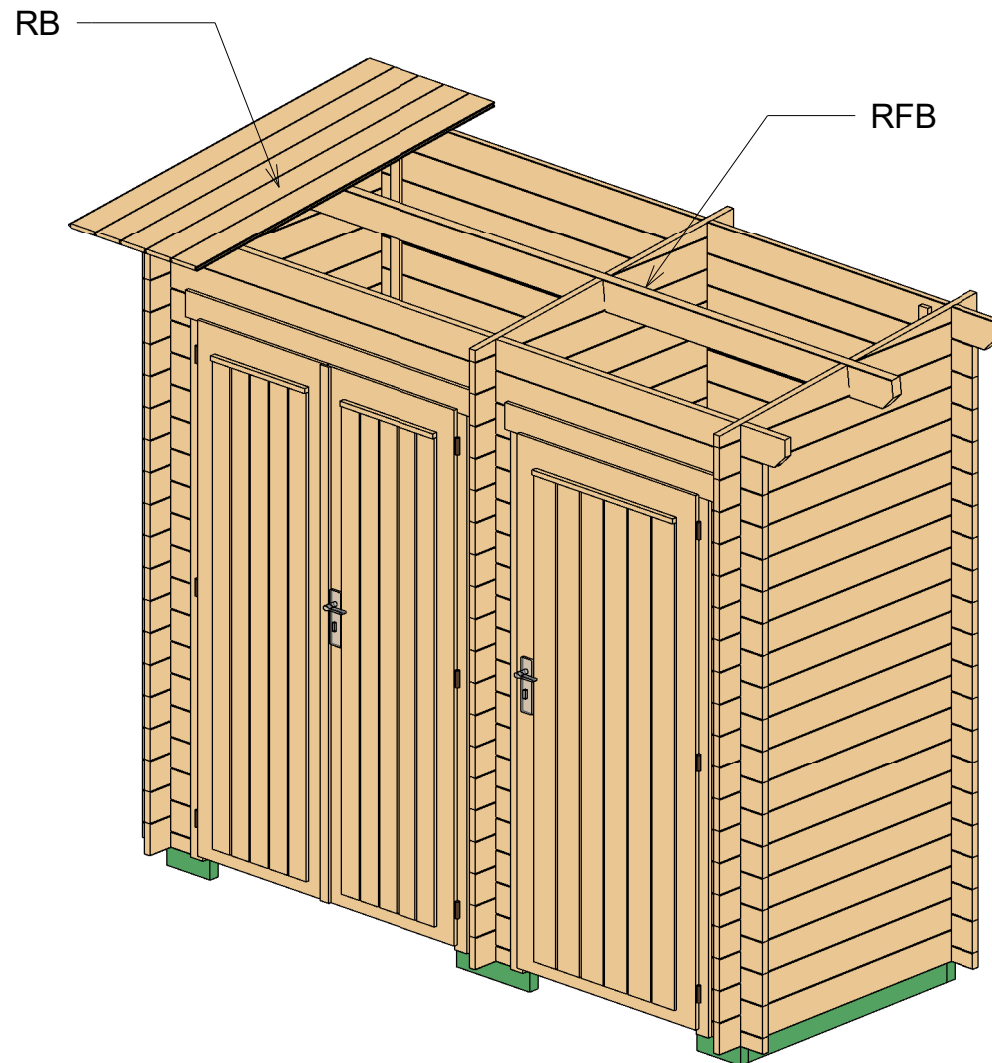
Roof 1



Roof				
Mark	Type	Profile	Count	Length
RFB	Beam 40x120		1	3000
RB	17x114		27	1457

Waste House 28 (260x105)

Roof 2

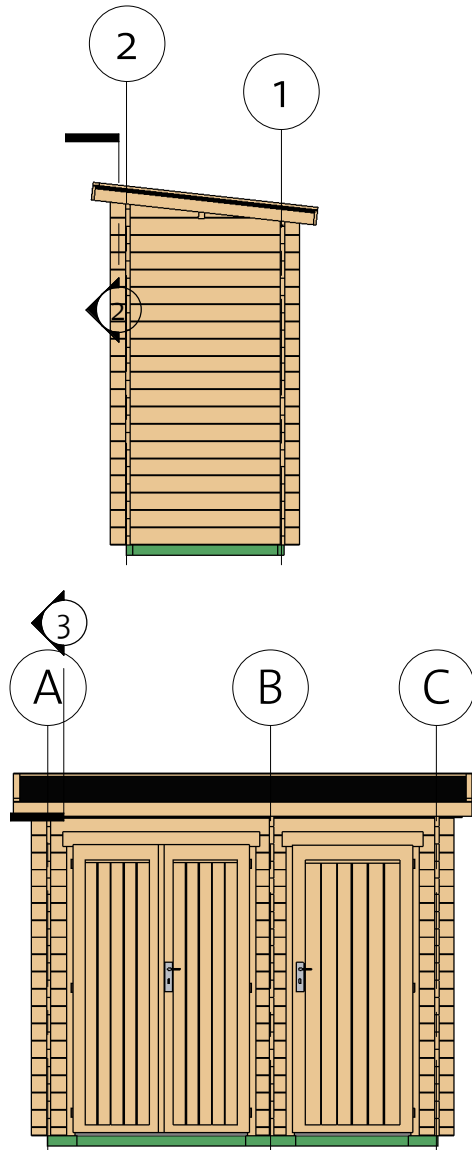

② Facia

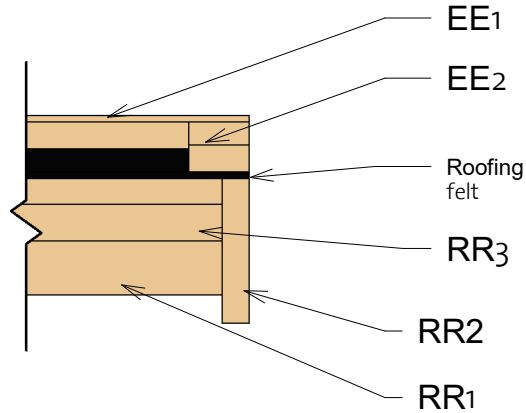

③ Roof Reinforcement

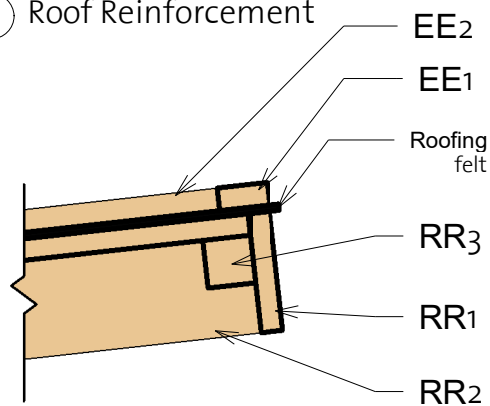

Fascia Schedule

Mark	Type	Profile	Count	Length
EE1	Eave Edging 18x40		1	3036
EE2	Eave Edging 18x40		2	1453
RR1	Roof reinforcement 18x95		2	3036
RR2	Roof reinforcement 18x95		2	1457
RR3	Roof reinforcement 38x38		2	3000

Waste House 28 (260x105)

Extras

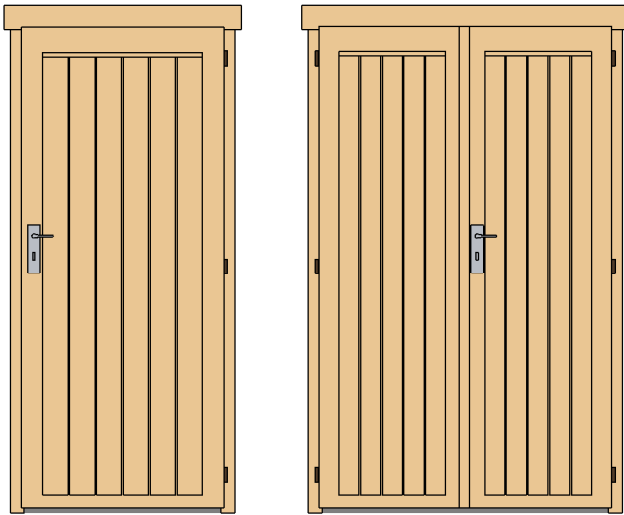

Door Schedule				
Model	Type	Width	Height	Count
BD2R	Basic door 2, wood right	840	1955	1
BDD13R	Basic double door 13, wood right	1200	1955	1

Type	Count	Length
Windboard 18x40 2250	2	2250
Windboard 18x40x2150	2	2150

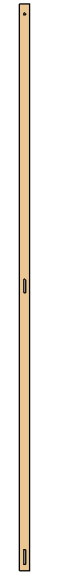

Fasteners/Extras		
Name	Type	Count

Hitblock	300-400 mm	
Bolts	M8 x 60	12
Screws	5,0 x 70	15
Screws	6,0 x 140	30
Screws	4,0 x 40	50
Screws	4,0 x 50	90



Waste House 28 (260x105)

List of all items 1





Impregnated foundation beams				
Mark	Type	Profile	Count	Length

IFB1	IFB 40x70		1	2590
IFB2	IFB 40x70		3	960
IFB3	IFB 40x70		2	195
IFB4	IFB 40x70		1	330

Roof				
Mark	Type	Profile	Count	Length

RFB	Beam 40x120		1	3000
RB	17x114		27	1457

Fascia Schedule				
Mark	Type	Profile	Count	Length

EE1	Eave Edging 18x40		1	3036
EE2	Eave Edging 18x40		2	1453
RR1	Roof reinforce ment 18x95		2	3036
RR2	Roof reinforce ment 18x95		2	1457
RR3	Roof reinforce ment 38x38		2	3000

Waste House 28 (260x105)

List of all items 2

Wall 1			
Mark	Profile	Count	Cut Length

1BL-1	28x57	1	235
1BL-2	28x57	2	250
1LG-1	28x114	17	235
1LG-2	28x114	34	250
1LG-3	28x114	1	2800
1TL-1	28x114	1	3000

Wall A			
Mark	Profile	Count	Cut Length

ALG-1*	28x114	1	593
ALG-2	28x114	19	1250
ALG-3*	28x114	1	1250

Wall C			
Mark	Profile	Count	Cut Length

CLG-1*	28x114	1	593
CLG-2	28x114	19	1250
CLG-3*	28x114	1	1250

Log profiles	
Profile	Profile

28x114	
--------	---

Wall 2			
Mark	Profile	Count	Cut Length

2BL-1	28x57	1	2800
2LG-1	28x114	19	2800
2TL-1	28x114	1	3000

Wall B			
Mark	Profile	Count	Cut Length

BLG-1*	28x114	1	593
BLG-2	28x114	19	1250
BLG-3*	28x114	1	1250

* Gable - delivered premounted

Log profiles	
Profile	Profile

28x57	
28x114	